

IEEE Std 802.11a-1999(R2003)
(Supplement to IEEE Std 802.11-1999)

[Adopted by ISO/IEC and redesignated as
ISO/IEC 8802-11:1999/Amd 1:2000(E)]

**Supplement to IEEE Standard for Information technology—
Telecommunications and information exchange between systems—
Local and metropolitan area networks—
Specific requirements**

Part 11: Wireless LAN Medium Access Control (MAC) and Physical Layer (PHY) specifications

High-speed Physical Layer in the 5 GHz Band

**Adopted by the ISO/IEC and redesignated as
ISO/IEC 8802-11:1999/Amd 1:2000(E)**

Sponsor

**LAN/MAN Standards Committee
of the
IEEE Computer Society**

IEEE Standards documents are developed within the IEEE Societies and the Standards Coordinating Committees of the IEEE Standards Association (IEEE-SA) Standards Board. Members of the committees serve voluntarily and without compensation. They are not necessarily members of the Institute. The standards developed within IEEE represent a consensus of the broad expertise on the subject within the Institute as well as those activities outside of IEEE that have expressed an interest in participating in the development of the standard.

Use of an IEEE Standard is wholly voluntary. The existence of an IEEE Standard does not imply that there are no other ways to produce, test, measure, purchase, market, or provide other goods and services related to the scope of the IEEE Standard. Furthermore, the viewpoint expressed at the time a standard is approved and issued is subject to change brought about through developments in the state of the art and comments received from users of the standard. Every IEEE Standard is subjected to review at least every five years for revision or reaffirmation. When a document is more than five years old and has not been reaffirmed, it is reasonable to conclude that its contents, although still of some value, do not wholly reflect the present state of the art. Users are cautioned to check to determine that they have the latest edition of any IEEE Standard.

Comments for revision of IEEE Standards are welcome from any interested party, regardless of membership affiliation with IEEE. Suggestions for changes in documents should be in the form of a proposed change of text, together with appropriate supporting comments.

Interpretations: Occasionally questions may arise regarding the meaning of portions of standards as they relate to specific applications. When the need for interpretations is brought to the attention of IEEE, the Institute will initiate action to prepare appropriate responses. Since IEEE Standards represent a consensus of all concerned interests, it is important to ensure that any interpretation has also received the concurrence of a balance of interests. For this reason, IEEE and the members of its societies and Standards Coordinating Committees are not able to provide an instant response to interpretation requests except in those cases where the matter has previously received formal consideration.

Comments on standards and requests for interpretations should be addressed to:

Secretary, IEEE-SA Standards Board
445 Hoes Lane
P.O. Box 1331
Piscataway, NJ 08855-1331
USA

<p>Note: Attention is called to the possibility that implementation of this standard may require use of subject matter covered by patent rights. By publication of this standard, no position is taken with respect to the existence or validity of any patent rights in connection therewith. The IEEE shall not be responsible for identifying patents for which a license may be required by an IEEE standard or for conducting inquiries into the legal validity or scope of those patents that are brought to its attention.</p>

Authorization to photocopy portions of any individual standard for internal or personal use is granted by the Institute of Electrical and Electronics Engineers, Inc., provided that the appropriate fee is paid to Copyright Clearance Center. To arrange for payment of licensing fee, please contact Copyright Clearance Center, Customer Service, 222 Rosewood Drive, Danvers, MA 01923 USA; (978) 750-8400. Permission to photocopy portions of any individual standard for educational classroom use can also be obtained through the Copyright Clearance Center.

Introduction

(This introduction is not part of IEEE Std 802.11a-1999, Supplement to IEEE Standard for Information technology—Telecommunications and information exchange between systems—Local and metropolitan area networks—Specific Requirements—Part 11: Wireless LAN Medium Access Control (MAC) and Physical Layer (PHY) specifications: High-speed Physical Layer in the 5 GHz Band.)

This standard is part of a family of standards for local and metropolitan area networks. The relationship between the standard and other members of the family is shown below. (The numbers in the figure refer to IEEE standard numbers.)

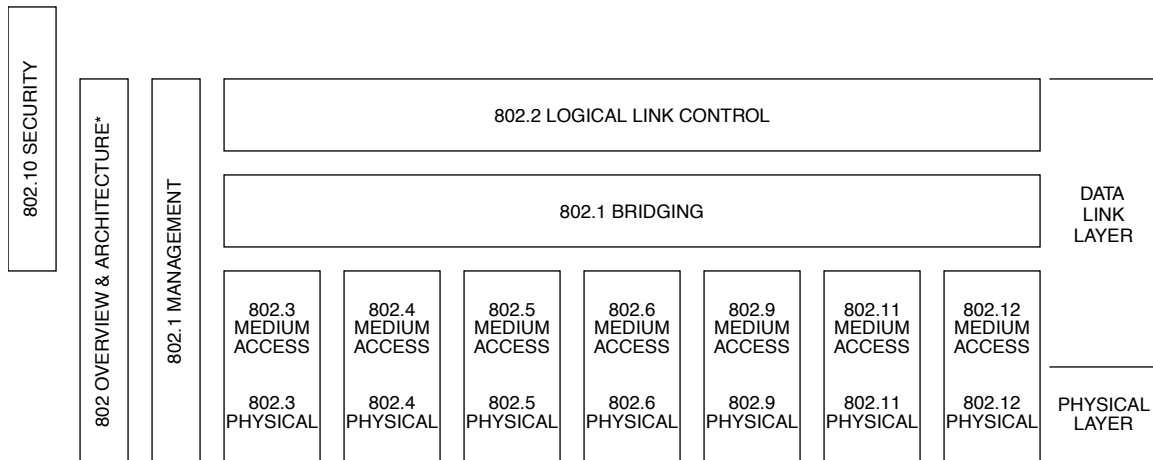

* Formerly IEEE Std 802.1A.

This family of standards deals with the Physical and Data Link layers as defined by the International Organization for Standardization (ISO) Open Systems Interconnection (OSI) Basic Reference Model (ISO/IEC 7498-1:1994). The access standards define seven types of medium access technologies and associated physical media, each appropriate for particular applications or system objectives. Other types are under investigation.

The standards defining the access technologies are as follows:

- IEEE Std 802 *Overview and Architecture*. This standard provides an overview to the family of IEEE 802 Standards.
- ANSI/IEEE Std 802.1B and 802.1k [ISO/IEC 15802-2] *LAN/MAN Management*. Defines an OSI management-compatible architecture, and services and protocol elements for use in a LAN/MAN environment for performing remote management.
- ANSI/IEEE Std 802.1D [ISO/IEC 15802-3] *Media Access Control (MAC) Bridges*. Specifies an architecture and protocol for the interconnection of IEEE 802 LANs below the MAC service boundary.
- ANSI/IEEE Std 802.1E [ISO/IEC 15802-4] *System Load Protocol*. Specifies a set of services and protocol for those aspects of management concerned with the loading of systems on IEEE 802 LANs.
- IEEE Std 802.1F *Common Definitions and Procedures for IEEE 802 Management Information*
- ANSI/IEEE Std 802.1G [ISO/IEC 15802-5] *Remote Media Access Control Bridging*. Specifies extensions for the interconnection, using non-LAN communication technologies, of geographically separated IEEE 802 LANs below the level of the logical link control protocol.

- ANSI/IEEE Std 802.2 [ISO/IEC 8802-2] *Logical Link Control*
- ANSI/IEEE Std 802.3 [ISO/IEC 8802-3] *CSMA/CD Access Method and Physical Layer Specifications*
- ANSI/IEEE Std 802.4 [ISO/IEC 8802-4] *Token Passing Bus Access Method and Physical Layer Specifications*
- ANSI/IEEE Std 802.5 [ISO/IEC 8802-5] *Token Ring Access Method and Physical Layer Specifications*
- ANSI/IEEE Std 802.6 [ISO/IEC 8802-6] *Distributed Queue Dual Bus Access Method and Physical Layer Specifications*
- ANSI/IEEE Std 802.9 [ISO/IEC 8802-9] *Integrated Services (IS) LAN Interface at the Medium Access Control and Physical Layers*
- ANSI/IEEE Std 802.10 *Interoperable LAN/MAN Security*
- IEEE Std 802.11 [ISO/IEC DIS 8802-11] *Wireless LAN Medium Access Control and Physical Layer Specifications*
- ANSI/IEEE Std 802.12 [ISO/IEC DIS 8802-12] *Demand Priority Access Method, Physical Layer and Repeater Specifications*

In addition to the family of standards, the following is a recommended practice for a common Physical Layer technology:

- IEEE Std 802.7 *IEEE Recommended Practice for Broadband Local Area Networks*

The following additional working groups have authorized standards projects under development:

- IEEE 802.14 *Standard Protocol for Cable-TV Based Broadband Communication Network*
- IEEE 802.15 *Wireless Personal Area Networks Access Method and Physical Layer Specifications*
- IEEE 802.16 *Broadband Wireless Access Method and Physical Layer Specifications*

Editor's Notes

Clause 4, subclause 9.1, and Clause 17 in this supplement will be inserted into the base standard as an additional PHY specification for the 5 GHz unlicensed national information infrastructure (U-NII) band.

There are three annexes included in this supplement. Following are instructions to merge the information in these annexes into the base document.

Annex A: This annex shows a change to the table in A.4.3 of the base standard (IUT configuration) and the addition of a new subclause. Item *CF6 should be added to the table in A.4.3 of the base standard. The entire subclause A.4.8 (Orthogonal frequency division multiplex PHY functions) should be added to the end of Annex A in the base standard (i.e., after A.4.7).

Annex D: This annex contains additions to be made to Annex D (ASN.1 encoding of the MAC and PHY MIB) of the base standard. There are five sections that provide instructions to merge the information contained herein into the appropriate locations in Annex D of the base standard.

Annex G: This annex is new to the base standard. The purpose of Annex G is to provide an example of encoding a frame for the OFDM PHY, described in Clause 17, including all intermediate stages.

Participants

At the time this standard was balloted, the 802.11 working group had the following membership:

Vic Hayes, *Chair*

Stuart J. Kerry, *Vice Chair*

Al Petrick, *Co-Vice Chair*

George Fishel, *Secretary*

Robert O'Hara, *Chair and editor, 802.11-rev*

Allen Heberling, *State-diagram editor*

Michael A. Fischer, *State-diagram editor*

Dean M. Kawaguchi, *Chair PHY group*

David Bagby, *Chair MAC group*

Naftali Chayat, *Chair Task Group a*

Hitoshi Takanashi, *Editor 802.11a*

John Fakatselis, *Chair Task Group b*

Carl F. Andren, *Editor 802.11b*

Jeffrey Abramowitz
Reza Ahy
Keith B. Amundsen
James R. Baker
Kevin M. Barry
Phil Belanger
John Biddick
Simon Black
Timothy J. Blaney
Jan Boer
Ronald Brockmann
Wesley Brodsky
John H. Cafarella
Wen-Chiang Chen
Ken Clements
Wim Diepstraten
Peter Ecclesine
Richard Eckard
Darwin Engwer
Greg Ennis
Jeffrey J. Fischer
John Fisher
Ian Gifford
Motohiro Gochi
Tim Godfrey
Steven D. Gray
Jan Haag
Karl Hannestad
Kei Hara

Chris D. Heegard
Robert Heile
Juha T. Heiskala
Maarten Hoeben
Masayuki Ikeda
Donald C. Johnson
Tal Kaitz
Ad Kamerman
Mika Kasslin
Patrick Kinney
Steven Knudsen
Bruce P. Kraemer
David S. Landeta
James S. Li
Stanley Ling
Michael D. McInnis
Gene Miller
Akira Miura
Henri Moelard
Masaharu Mori
Masahiro Morikura
Richard van Nee
Erwin R. Noble
Tomoki Ohsawa
Kazuhiro Okanoue
Richard H. Paine
Roger Pandanda
Victoria M. Poncini
Gregory S. Rawlins
Stanley A. Reible

Frits Riep
William Roberts
Kent G. Rollins
Clemens C.W. Ruppel
Anil K. Sanwalka
Roy Sebring
Tie-Jun Shan
Stephen J. Shellhammer
Matthew B. Shoemake
Thomas Siep
Donald I. Sloan
Gary Spiess
Satoru Toguchi
Cherry Tom
Mike Trompower
Tom Tsoulogiannis
Bruce Tuch
Sarosh N. Vesuna
Ikuo Wakayama
Robert M. Ward, Jr.
Mark Webster
Leo Wilz
Harry R. Worstell
Lawrence W. Yonge, III
Chris Zegelin
Jonathan M. Zweig
James Zyren

The following members of the balloting committee voted on this standard:

Carl F. Andren	Raj Jain	Pete Rautenberg
Jack S. Andresen	A. Kamerman	Stanley A. Reible
Lek Ariyavitakul	Dean M. Kawaguchi	Edouard Y. Rocher
David Bagby	Stuart J. Kerry	Kent Rollins
Kevin M. Barry	Patrick Kinney	James W. Romlein
John H. Cafarella	Daniel R. Krent	Floyd E. Ross
James T. Carlo	Walter Levy	Christoph Ruland
David E. Carlson	Stanley Ling	Anil K. Sanwalka
Linda T. Cheng	Randolph S. Little	Norman Schneidewind
Thomas J. Dineen	Roger B. Marks	James E. Schuessler
Christos Douligeris	Peter Martini	Rich Seifert
Peter Ecclesine	Richard McBride	Matthew B. Shoemake
Richard Eckard	Bennett Meyer	Leo Sintonen
Philip H. Enslow	David S. Millman	Hitoshi Takanashi
John Fakatselis	Hiroshi Miyano	Mike Trompower
Jeffrey J. Fischer	Warren Monroe	Mark-Rene Uchida
Michael A. Fischer	Masahiro Morikura	Scott A. Valcourt
Robert J. Gagliano	Shimon Muller	Richard Van Nee
Gautam Garai	Peter A. Murphy	Sarosh N. Vesuna
Alireza Ghazizahedi	Paul Nikolich	John Viaplana
Tim Godfrey	Erwin R. Noble	Hirohisa Wakai
Patrick S. Gonia	Satoshi Obara	Robert M. Ward, Jr.
Steven D. Gray	Robert O'Hara	Mark Webster
Chris G. Guy	Charles Oestereicher	Harry R. Worstell
Vic Hayes	Kazuhiro Okanoue	Stefan M. Wurster
Allen Heberling	Roger Pandanda	Oren Yuen
Chris D. Heegard	Ronald C. Petersen	Jonathan M. Zweig
Juha T. Heiskala	Al Petrick	James Zyren
	Vikram Punj	

When the IEEE-SA Standards Board approved this standard on 16 September 1999, it had the following membership:

Richard J. Holleman, *Chair*
Donald N. Heirman, *Vice Chair*
Judith Gorman, *Secretary*

Satish K. Aggarwal	James H. Gurney	Louis-François Pau
Dennis Bodson	Lowell G. Johnson	Ronald C. Petersen
Mark D. Bowman	Robert J. Kennelly	Gerald H. Peterson
James T. Carlo	E. G. "Al" Kiener	John B. Posey
Gary R. Engmann	Joseph L. Koepfinger*	Gary S. Robinson
Harold E. Epstein	L. Bruce McClung	Akio Tojo
Jay Forster*	Daleep C. Mohla	Hans E. Weinrich
Ruben D. Garzon	Robert F. Munzner	Donald W. Zipse

**Member Emeritus

Also included is the following nonvoting IEEE-SA Standards Board liaison:

Robert E. Hebner

Janet Rutigliano
IEEE Standards Project Editor

Contents

Editor's Notes.....	v
4. Abbreviations and acronyms.....	2
9.1 Multirate support.....	2
10.4 PLME SAP interface.....	2
17. OFDM PHY specification for the 5 GHz band.....	3
17.1 Introduction.....	3
17.2 OFDM PHY specific service parameter list	5
17.3 OFDM PLCP sublayer.....	7
17.4 OFDM PLME	34
17.5 OFDM PMD sublayer.....	39
Annex A (normative), Protocol Implementation Conformance Statement (PICS) proforma	46
Annex D (normative), ASN.1 encoding of the MAC and PHY MIB.....	51
Annex G (informative), An example of encoding a frame for OFDM PHY	54

**Supplement to IEEE Standard for
Information technology—
Telecommunications and information exchange
between systems—
Local and metropolitan area networks—
Specific requirements—**

**Part 11: Wireless LAN Medium Access
Control (MAC) and Physical Layer
(PHY) specifications:**

**High-speed Physical Layer in the
5 GHz Band**

[These additions are based on IEEE Std 802.11, 1999 Edition.]

EDITORIAL NOTE—The editing instructions contained in this supplement define how to merge the material contained herein into IEEE Std 802.11, 1999 Edition, to form the new comprehensive standard as created by the addition of IEEE Std 802.11a-1999.

The editing instructions are shown in ***bold italic***. Three editing instructions are used: change, delete, and insert. ***Change*** is used to make small corrections to existing text or tables. The editing instruction specifies the location of the change and describes what is being changed either by using ~~striketrough~~ (to remove old material) or underscore (to add new material). ***Delete*** removes existing material. ***Insert*** adds new material without disturbing the existing material. Insertions may require renumbering. If so, renumbering instructions are given in the editing instructions. Editorial notes will not be carried over into future editions.

4. Abbreviations and acronyms

Insert the following acronyms alphabetically in the list in Clause 4:

BPSK	binary phase shift keying
C-MPDU	coded MPDU
FFT	Fast Fourier Transform
GI	guard interval
IFFT	inverse Fast Fourier Transform
OFDM	orthogonal frequency division multiplexing
PER	packet error rate
QAM	quadrature amplitude modulation
QPSK	quadrature phase shift keying
U-NII	unlicensed national information infrastructure

9.1 Multirate support

Add the following text to the end of 9.6:

For the 5 GHz PHY, the time required to transmit a frame for use in the Duration/ID field is determined using the PLME-TXTIME.request primitive and the PLME-TXTIME.confirm primitive. The calculation method of TXTIME duration is defined in 17.4.3.

10.4 PLME SAP interface

Add the following text to the end of 10.4:

Remove the references to aMPDUDurationFactor from 10.4.3.1.

Add the following subclauses at the end of 10.4:

10.4.6 PLME-TXTIME.request

10.4.6.1 Function

This primitive is a request for the PHY to calculate the time that will be required to transmit onto the wireless medium a PPDU containing a specified length MPDU, and using a specified format, data rate, and signalling.

10.4.6.2 Semantics of the service primitive

This primitive provides the following parameters:

PLME-TXTIME.request(TXVECTOR)

The TXVECTOR represents a list of parameters that the MAC sublayer provides to the local PHY entity in order to transmit a MPDU, as further described in 12.3.4.4 and 17.4 (which defines the local PHY entity).

10.4.6.3 When generated

This primitive is issued by the MAC sublayer to the PHY entity whenever the MAC sublayer needs to determine the time required to transmit a particular MPDU.

10.4.6.4 Effect of receipt

The effect of receipt of this primitive by the PHY entity shall be to generate a PHY-TXTIME.confirm primitive that conveys the required transmission time.

10.4.7 PLME-TXTIME.confirm

10.4.7.1 Function

This primitive provides the time that will be required to transmit the PPDU described in the corresponding PLME-TXTIME.request.

10.4.7.2 Semantics of the service primitive

This primitive provides the following parameters:

PLME-TXTIME.confirm(TXTIME)

The TXTIME represents the time in microseconds required to transmit the PPDU described in the corresponding PLME-TXTIME.request. If the calculated time includes a fractional microsecond, the TXTIME value is rounded up to the next higher integer.

10.4.7.3 When generated

This primitive is issued by the local PHY entity in response to a PLME-TXTIME.request.

10.4.7.4 Effect of receipt

The receipt of this primitive provides the MAC sublayer with the PPDU transmission time.

Add the entire Clause 17 to the base standard:

17. OFDM PHY specification for the 5 GHz band

17.1 Introduction

This clause specifies the PHY entity for an orthogonal frequency division multiplexing (OFDM) system and the additions that have to be made to the base standard to accommodate the OFDM PHY. The radio frequency LAN system is initially aimed for the 5.15–5.25, 5.25–5.35 and 5.725–5.825 GHz unlicensed national information structure (U-NII) bands, as regulated in the United States by the Code of Federal Regulations, Title 47, Section 15.407. The OFDM system provides a wireless LAN with data payload communication capabilities of 6, 9, 12, 18, 24, 36, 48, and 54 Mbit/s. The support of transmitting and receiving at data rates of 6, 12, and 24 Mbit/s is mandatory. The system uses 52 subcarriers that are modulated using binary or quadrature phase shift keying (BPSK/QPSK), 16-quadrature amplitude modulation (QAM), or 64-QAM. Forward error correction coding (convolutional coding) is used with a coding rate of 1/2, 2/3, or 3/4.

17.1.1 Scope

This subclause describes the PHY services provided to the IEEE 802.11 wireless LAN MAC by the 5 GHz (bands) OFDM system. The OFDM PHY layer consists of two protocol functions, as follows:

- a) A PHY convergence function, which adapts the capabilities of the physical medium dependent (PMD) system to the PHY service. This function is supported by the physical layer convergence procedure (PLCP), which defines a method of mapping the IEEE 802.11 PHY sublayer service data units (PSDU) into a framing format suitable for sending and receiving user data and management information between two or more stations using the associated PMD system.
- b) A PMD system whose function defines the characteristics and method of transmitting and receiving data through a wireless medium between two or more stations, each using the OFDM system.

17.1.2 OFDM PHY functions

The 5 GHz OFDM PHY architecture is depicted in the reference model shown in Figure 11 of IEEE Std 802.11, 1999 Edition (5.8). The OFDM PHY contains three functional entities: the PMD function, the PHY convergence function, and the layer management function. Each of these functions is described in detail in 17.1.2.1 through 17.1.2.4.

The OFDM PHY service is provided to the MAC through the PHY service primitives described in Clause 12 of IEEE Std 802.11, 1999 Edition.

17.1.2.1 PLCP sublayer

In order to allow the IEEE 802.11 MAC to operate with minimum dependence on the PMD sublayer, a PHY convergence sublayer is defined. This function simplifies the PHY service interface to the IEEE 802.11 MAC services.

17.1.2.2 PMD sublayer

The PMD sublayer provides a means to send and receive data between two or more stations. This clause is concerned with the 5 GHz band using OFDM modulation.

17.1.2.3 PHY management entity (PLME)

The PLME performs management of the local PHY functions in conjunction with the MAC management entity.

17.1.2.4 Service specification method

The models represented by figures and state diagrams are intended to be illustrations of the functions provided. It is important to distinguish between a model and a real implementation. The models are optimized for simplicity and clarity of presentation; the actual method of implementation is left to the discretion of the IEEE 802.11 OFDM PHY compliant developer.

The service of a layer or sublayer is the set of capabilities that it offers to a user in the next higher layer (or sublayer). Abstract services are specified here by describing the service primitives and parameters that characterize each service. This definition is independent of any particular implementation.

17.2 OFDM PHY specific service parameter list

17.2.1 Introduction

The architecture of the IEEE 802.11 MAC is intended to be PHY independent. Some PHY implementations require medium management state machines running in the MAC sublayer in order to meet certain PMD requirements. These PHY-dependent MAC state machines reside in a sublayer defined as the MAC sublayer management entity (MLME). In certain PMD implementations, the MLME may need to interact with the PLME as part of the normal PHY SAP primitives. These interactions are defined by the PLME parameter list currently defined in the PHY service primitives as TXVECTOR and RXVECTOR. The list of these parameters, and the values they may represent, are defined in the specific PHY specifications for each PMD. This subclause addresses the TXVECTOR and RXVECTOR for the OFDM PHY.

17.2.2 TXVECTOR parameters

The parameters in Table 76 are defined as part of the TXVECTOR parameter list in the PHY-TXSTART.request service primitive.

Table 76—TXVECTOR parameters

Parameter	Associate primitive	Value
LENGTH	PHY-TXSTART.request (TXVECTOR)	1–4095
DATARATE	PHY-TXSTART.request (TXVECTOR)	6, 9, 12, 18, 24, 36, 48, and 54 (Support of 6, 12, and 24 data rates is mandatory.)
SERVICE	PHY-TXSTART.request (TXVECTOR)	Scrambler initialization; 7 null bits + 9 reserved null bits
TXPWR_LEVEL	PHY-TXSTART.request (TXVECTOR)	1–8

17.2.2.1 TXVECTOR LENGTH

The allowed values for the LENGTH parameter are in the range of 1–4095. This parameter is used to indicate the number of octets in the MPDU which the MAC is currently requesting the PHY to transmit. This value is used by the PHY to determine the number of octet transfers that will occur between the MAC and the PHY after receiving a request to start the transmission.

17.2.2.2 TXVECTOR DATARATE

The DATARATE parameter describes the bit rate at which the PLCP shall transmit the PSDU. Its value can be any of the rates defined in Table 76. Data rates of 6, 12, and 24 shall be supported; other rates may also be supported.

17.2.2.3 TXVECTOR SERVICE

The SERVICE parameter consists of 7 null bits used for the scrambler initialization and 9 null bits reserved for future use.

17.2.2.4 TXVECTOR TXPWR_LEVEL

The allowed values for the TXPWR_LEVEL parameter are in the range from 1–8. This parameter is used to indicate which of the available TxPowerLevel attributes defined in the MIB shall be used for the current transmission.

17.2.3 RXVECTOR parameters

The parameters listed in Table 77 are defined as part of the RXVECTOR parameter list in the PHY-RXSTART.indicate service primitive.

Table 77—RXVECTOR parameters

Parameter	Associate primitive	Value
LENGTH	PHY-RXSTART.indicate	1–4095
RSSI	PHY-RXSTART.indicate (RXVECTOR)	0–RSSI maximum
DATARATE	PHY-RXSTART.request (RXVECTOR)	6, 9, 12, 18, 24, 36, 48, and 54
SERVICE	PHY-RXSTART.request (RXVECTOR)	Null

17.2.3.1 RXVECTOR LENGTH

The allowed values for the LENGTH parameter are in the range from 1–4095. This parameter is used to indicate the value contained in the LENGTH field which the PLCP has received in the PLCP header. The MAC and PLCP will use this value to determine the number of octet transfers that will occur between the two sublayers during the transfer of the received PSDU.

17.2.3.2 RXVECTOR RSSI

The allowed values for the receive signal strength indicator (RSSI) parameter are in the range from 0 through RSSI maximum. This parameter is a measure by the PHY sublayer of the energy observed at the antenna used to receive the current PPDU. RSSI shall be measured during the reception of the PLCP preamble. RSSI is intended to be used in a relative manner, and it shall be a monotonically increasing function of the received power.

17.2.3.3 DATARATE

DATARATE shall represent the data rate at which the current PPDU was received. The allowed values of the DATARATE are 6, 9, 12, 18, 24, 36, 48, or 54.

17.2.3.4 SERVICE

The SERVICE field shall be null.

17.3 OFDM PLCP sublayer

17.3.1 Introduction

This subclause provides a convergence procedure in which PSDUs are converted to and from PPDU. During transmission, the PSDU shall be provided with a PLCP preamble and header to create the PPDU. At the receiver, the PLCP preamble and header are processed to aid in demodulation and delivery of the PSDU.

17.3.2 PLCP frame format

Figure 107 shows the format for the PPDU including the OFDM PLCP preamble, OFDM PLCP header, PSDU, tail bits, and pad bits. The PLCP header contains the following fields: LENGTH, RATE, a reserved bit, an even parity bit, and the SERVICE field. In terms of modulation, the LENGTH, RATE, reserved bit, and parity bit (with 6 “zero” tail bits appended) constitute a separate single OFDM symbol, denoted SIGNAL, which is transmitted with the most robust combination of BPSK modulation and a coding rate of $R = 1/2$. The SERVICE field of the PLCP header and the PSDU (with 6 “zero” tail bits and pad bits appended), denoted as DATA, are transmitted at the data rate described in the RATE field and may constitute multiple OFDM symbols. The tail bits in the SIGNAL symbol enable decoding of the RATE and LENGTH fields immediately after the reception of the tail bits. The RATE and LENGTH are required for decoding the DATA part of the packet. In addition, the CCA mechanism can be augmented by predicting the duration of the packet from the contents of the RATE and LENGTH fields, even if the data rate is not supported by the station. Each of these fields is described in detail in 17.3.3, 17.3.4, and 17.3.5.

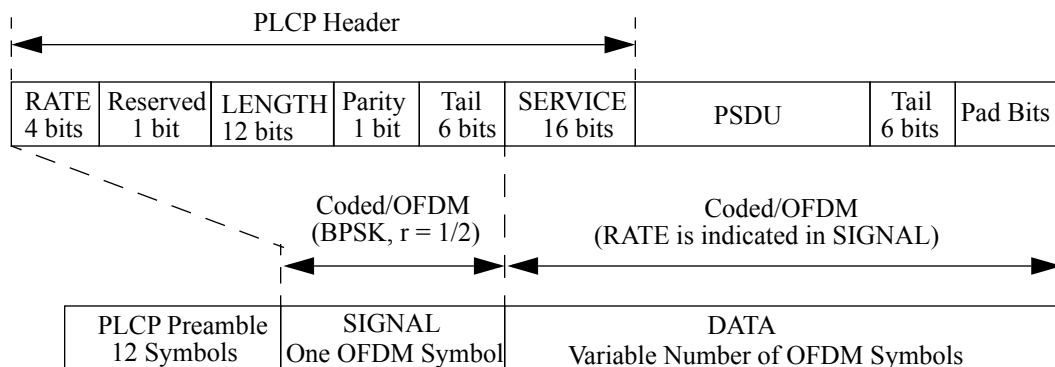

Figure 107—PPDU frame format

17.3.2.1 Overview of the PPDU encoding process

The encoding process is composed of many detailed steps, which are described fully in later subclauses, as noted below. The following overview intends to facilitate understanding the details described in these subclauses:

- Produce the PLCP preamble field, composed of 10 repetitions of a “short training sequence” (used for AGC convergence, diversity selection, timing acquisition, and coarse frequency acquisition in the receiver) and two repetitions of a “long training sequence” (used for channel estimation and fine frequency acquisition in the receiver), preceded by a guard interval (GI). Refer to 17.3.3 for details.

- b) Produce the PLCP header field from the RATE, LENGTH, and SERVICE fields of the TXVECTOR by filling the appropriate bit fields. The RATE and LENGTH fields of the PLCP header are encoded by a convolutional code at a rate of $R = 1/2$, and are subsequently mapped onto a single BPSK encoded OFDM symbol, denoted as the SIGNAL symbol. In order to facilitate a reliable and timely detection of the RATE and LENGTH fields, 6 “zero” tail bits are inserted into the PLCP header. The encoding of the SIGNAL field into an OFDM symbol follows the same steps for convolutional encoding, interleaving, BPSK modulation, pilot insertion, Fourier transform, and prepending a GI as described subsequently for data transmission at 6 Mbit/s. The contents of the SIGNAL field are not scrambled. Refer to 17.3.4 for details.
- c) Calculate from RATE field of the TXVECTOR the number of data bits per OFDM symbol (N_{DBPS}), the coding rate (R), the number of bits in each OFDM subcarrier (N_{BPSK}), and the number of coded bits per OFDM symbol (N_{CBPS}). Refer to 17.3.2.2 for details.
- d) Append the PSDU to the SERVICE field of the TXVECTOR. Extend the resulting bit string with “zero” bits (at least 6 bits) so that the resulting length will be a multiple of N_{DBPS} . The resulting bit string constitutes the DATA part of the packet. Refer to 17.3.5.4 for details.
- e) Initiate the scrambler with a pseudorandom non-zero seed, generate a scrambling sequence, and XOR it with the extended string of data bits. Refer to 17.3.5.4 for details.
- f) Replace the six scrambled “zero” bits following the “data” with six nonscrambled “zero” bits. (Those bits return the convolutional encoder to the “zero state” and are denoted as “tail bits.”) Refer to 17.3.5.2 for details.
- g) Encode the extended, scrambled data string with a convolutional encoder ($R = 1/2$). Omit (puncture) some of the encoder output string (chosen according to “puncturing pattern”) to reach the desired “coding rate.” Refer to 17.3.5.5 for details.
- h) Divide the encoded bit string into groups of N_{CBPS} bits. Within each group, perform an “interleaving” (reordering) of the bits according to a rule corresponding to the desired RATE. Refer to 17.3.5.6 for details.
- i) Divide the resulting coded and interleaved data string into groups of N_{CBPS} bits. For each of the bit groups, convert the bit group into a complex number according to the modulation encoding tables. Refer to 17.3.5.7 for details.
- j) Divide the complex number string into groups of 48 complex numbers. Each such group will be associated with one OFDM symbol. In each group, the complex numbers will be numbered 0 to 47 and mapped hereafter into OFDM subcarriers numbered -26 to -22 , -20 to -8 , -6 to -1 , 1 to 6 , 8 to 20 , and 22 to 26 . The subcarriers -21 , -7 , 7 , and 21 are skipped and, subsequently, used for inserting pilot subcarriers. The “0” subcarrier, associated with center frequency, is omitted and filled with zero value. Refer to 17.3.5.9 for details.
- k) Four subcarriers are inserted as pilots into positions -21 , -7 , 7 , and 21 . The total number of the subcarriers is 52 ($48 + 4$). Refer to 17.3.5.8 for details.
- l) For each group of subcarriers -26 to 26 , convert the subcarriers to time domain using inverse Fourier transform. Prepend to the Fourier-transformed waveform a circular extension of itself thus forming a GI, and truncate the resulting periodic waveform to a single OFDM symbol length by applying time domain windowing. Refer to 17.3.5.9 for details.
- m) Append the OFDM symbols one after another, starting after the SIGNAL symbol describing the RATE and LENGTH. Refer to 17.3.5.9 for details.
- n) Up-convert the resulting “complex baseband” waveform to an RF frequency according to the center frequency of the desired channel and transmit. Refer to 17.3.2.4 and 17.3.8.1 for details.

An illustration of the transmitted frame and its parts appears in Figure 110 of 17.3.3.

17.3.2.2 RATE-dependent parameters

The modulation parameters dependent on the data rate used shall be set according to Table 78.

Table 78—Rate-dependent parameters

Data rate (Mbits/s)	Modulation	Coding rate (R)	Coded bits per subcarrier (N _{BPSC})	Coded bits per OFDM symbol (N _{CBPS})	Data bits per OFDM symbol (N _{DBPS})
6	BPSK	1/2	1	48	24
9	BPSK	3/4	1	48	36
12	QPSK	1/2	2	96	48
18	QPSK	3/4	2	96	72
24	16-QAM	1/2	4	192	96
36	16-QAM	3/4	4	192	144
48	64-QAM	2/3	6	288	192
54	64-QAM	3/4	6	288	216

17.3.2.3 Timing related parameters

Table 79 is the list of timing parameters associated with the OFDM PLCP.

Table 79—Timing-related parameters

Parameter	Value
N _{SD} : Number of data subcarriers	48
N _{SP} : Number of pilot subcarriers	4
N _{ST} : Number of subcarriers, total	52 (N _{SD} + N _{SP})
Δ _F : Subcarrier frequency spacing	0.3125 MHz (=20 MHz/64)
T _{FFT} : IFFT/FFT period	3.2 μs (1/Δ _F)
T _{PREAMBLE} : PLCP preamble duration	16 μs (T _{SHORT} + T _{LONG})
T _{SIGNAL} : Duration of the SIGNAL BPSK-OFDM symbol	4.0 μs (T _{GI} + T _{FFT})
T _{GI} : GI duration	0.8 μs (T _{FFT} /4)
T _{GI2} : Training symbol GI duration	1.6 μs (T _{FFT} /2)
T _{SYM} : Symbol interval	4 μs (T _{GI} + T _{FFT})
T _{SHORT} : Short training sequence duration	8 μs (10 × T _{FFT} /4)
T _{LONG} : Long training sequence duration	8 μs (T _{GI2} + 2 × T _{FFT})

17.3.2.4 Mathematical conventions in the signal descriptions

The transmitted signals will be described in a complex baseband signal notation. The actual transmitted signal is related to the complex baseband signal by the following relation:

$$r_{(RF)(t)} = \text{Re}\{r(t)\exp\langle j2\pi f_c t \rangle\} \quad (1)$$

where

$\text{Re}(\cdot)$ represents the real part of a complex variable;
 f_c denotes the carrier center frequency.

The transmitted baseband signal is composed of contributions from several OFDM symbols.

$$r_{\text{PACKET}}(t) = r_{\text{PREAMBLE}}(t) + r_{\text{SIGNAL}}(t - t_{\text{SIGNAL}}) + r_{\text{DATA}}(t - t_{\text{DATA}}) \quad (2)$$

The subframes of which Equation (2) are composed are described in 17.3.3, 17.3.4, and 17.3.5.9. The time offsets t_{SUBFRAME} determine the starting time of the corresponding subframe; t_{SIGNAL} is equal to 16 μs , and t_{DATA} is equal to 20 μs .

All the subframes of the signal are constructed as an inverse Fourier transform of a set of coefficients, C_k , with C_k defined later as data, pilots, or training symbols in 17.3.3 through 17.3.5.

$$r_{\text{SUBFRAME}}(t) = w_{\text{SUBFRAME}}(t) \sum_{k=-N_{ST}/2}^{N_{ST}/2} C_k \exp(j2\pi k \Delta_f)(t - T_{\text{GUARD}}) \quad (3)$$

The parameters Δ_f and N_{ST} are described in Table 79. The resulting waveform is periodic with a period of $T_{\text{FFT}} = 1/\Delta_f$. Shifting the time by T_{GUARD} creates the “circular prefix” used in OFDM to avoid ISI from the previous frame. Three kinds of T_{GUARD} are defined: for the short training sequence (= 0 μs), for the long training sequence (= T_{GI2}), and for data OFDM symbols (= T_{GI}). (Refer to Table 79.) The boundaries of the subframe are set by a multiplication by a time-windowing function, $w_{\text{SUBFRAME}}(t)$, which is defined as a rectangular pulse, $w_T(t)$, of duration T , accepting the value T_{SUBFRAME} . The time-windowing function, $w_T(t)$, depending on the value of the duration parameter, T , may extend over more than one period, T_{FFT} . In particular, window functions that extend over multiple periods of the Fast Fourier Transform (FFT) are utilized in the definition of the preamble. Figure 108 illustrates the possibility of extending the windowing function over more than one period, T_{FFT} , and additionally shows smoothed transitions by application of a windowing function, as exemplified in Equation (4). In particular, window functions that extend over multiple periods of the FFT are utilized in the definition of the preamble.

$$w_T(t) = \begin{cases} \sin^2\left(\frac{\pi}{2}(0.5 + t/T_{TR})\right) & (-T_{TR}/2 < t < T_{TR}/2) \\ 1 & (T_{TR}/2 \leq t < T - T_{TR}/2) \\ \sin^2\left(\frac{\pi}{2}(0.5 - (t - T)/T_{TR})\right) & (T - T_{TR}/2 \leq t < T + T_{TR}/2) \end{cases} \quad (4)$$

In the case of vanishing T_{TR} , the windowing function degenerates into a rectangular pulse of duration T . The normative specifications of generating the transmitted waveforms shall utilize the rectangular pulse shape. In implementation, higher T_{TR} is typically implemented in order to smooth the transitions between the consecutive subsections. This creates a small overlap between them, of duration T_{TR} , as shown in Figure 108. The transition time, T_{TR} , is about 100 ns. Smoothing the transition is required in order to reduce the spectral side-lobes of the transmitted waveform. However, the binding requirements are the spectral mask and modulation accuracy requirements, as detailed in 17.3.9.2 and 17.3.9.6. Time domain windowing, as described here, is just one way to achieve those objectives. The implementor may use other methods to achieve the same goal, such as frequency domain filtering. Therefore, the transition shape and duration of the transition are informative parameters.

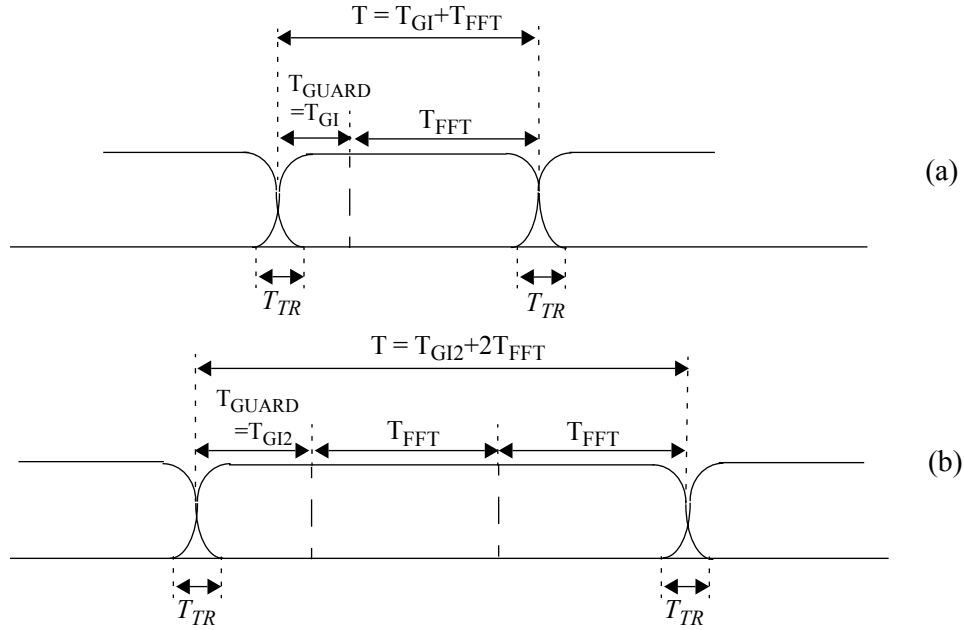

Figure 108—Illustration of OFDM frame with cyclic extension and windowing for (a) single reception or (b) two receptions of the FFT period

17.3.2.5 Discrete time implementation considerations

The following descriptions of the discrete time implementation are informational.

In a typical implementation, the windowing function will be represented in discrete time. As an example, when a windowing function with parameters $T = 4.0 \mu\text{s}$ and a $T_{TR} = 100 \text{ ns}$ is applied, and the signal is sampled at 20 Msamples/s, it becomes

$$w_T[n] = w_T(nT_S) = \begin{cases} 1 & 1 \leq n \leq 79 \\ 0.5 & 0, 80 \\ 0 & \text{otherwise} \end{cases} \quad (5)$$

The common way to implement the inverse Fourier transform, as shown in Equation (3), is by an inverse Fast Fourier Transform (IFFT) algorithm. If, for example, a 64-point IFFT is used, the coefficients 1 to 26 are mapped to the same numbered IFFT inputs, while the coefficients -26 to -1 are copied into IFFT inputs

38 to 63. The rest of the inputs, 27 to 37 and the 0 (dc) input, are set to zero. This mapping is illustrated in Figure 109. After performing an IFFT, the output is cyclically extended to the desired length.

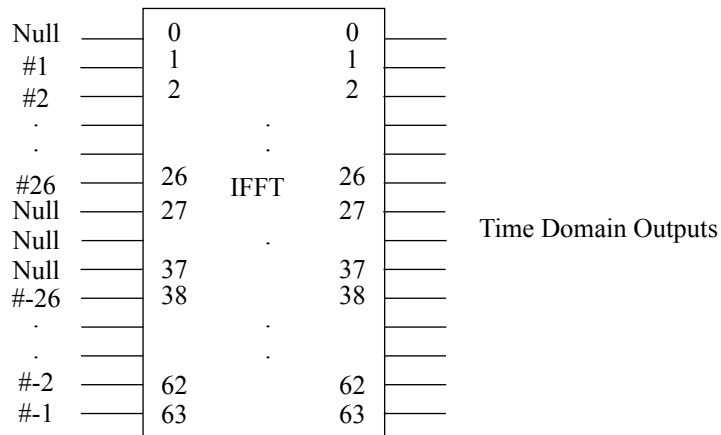

Figure 109—Inputs and outputs of IDFT

17.3.3 PLCP preamble (SYNC)

The PLCP preamble field is used for synchronization. It consists of 10 short symbols and two long symbols that are shown in Figure 110 and described in this subclause.

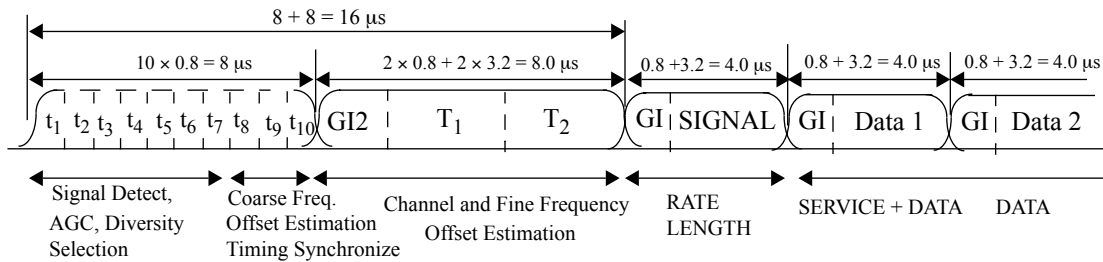

Figure 110—OFDM training structure

Figure 110 shows the OFDM training structure (PLCP preamble), where t_1 to t_{10} denote short training symbols and T_1 and T_2 denote long training symbols. The PLCP preamble is followed by the SIGNAL field and DATA. The total training length is 16 μ s. The dashed boundaries in the figure denote repetitions due to the periodicity of the inverse Fourier transform.

A short OFDM training symbol consists of 12 subcarriers, which are modulated by the elements of the sequence S , given by

$$S_{-26, 26} = \sqrt{(13/6)} \times \{0, 0, 1+j, 0, 0, 0, -1-j, 0, 0, 0, 1+j, 0, 0, 0, -1-j, 0, 0, 0, -1-j, 0, 0, 0, 1+j, 0, 0, 0, 0, 0, 0, 0, -1-j, 0, 0, 0, -1-j, 0, 0, 0, 1+j, 0, 0, 0, 1+j, 0, 0, 0, 1+j, 0, 0, 0, 1+j, 0, 0\} \quad (6)$$

The multiplication by a factor of $\sqrt{(13/6)}$ is in order to normalize the average power of the resulting OFDM symbol, which utilizes 12 out of 52 subcarriers.

The signal shall be generated according to the following equation:

$$r_{SHORT}(t) = w_{TSHORT}(t) \sum_{k=-N_{ST}/2}^{N_{ST}/2} S_k \exp(j2\pi k \Delta_F t) \quad (7)$$

The fact that only spectral lines of $S_{-26:26}$ with indices that are a multiple of 4 have nonzero amplitude results in a periodicity of $T_{FFT}/4 = 0.8 \mu\text{s}$. The interval T_{SHORT} is equal to ten $0.8 \mu\text{s}$ periods (i.e., $8 \mu\text{s}$).

Generation of the short training sequence is illustrated in Annex G (G.3.1, Table G.2).

A long OFDM training symbol consists of 53 subcarriers (including a zero value at dc), which are modulated by the elements of the sequence L, given by

$$L_{-26,26} = \{1, 1, -1, -1, 1, 1, -1, 1, -1, 1, 1, 1, 1, 1, 1, -1, -1, 1, 1, -1, 1, -1, 1, 1, 1, 0, \\ 1, -1, -1, 1, 1, -1, 1, -1, 1, -1, -1, -1, -1, -1, 1, 1, -1, -1, 1, -1, 1, -1, 1, 1, 1, 1\} \quad (8)$$

A long OFDM training symbol shall be generated according to the following equation:

$$r_{LONG}(t) = w_{TLONG}(t) \sum_{k=-N_{ST}/2}^{N_{ST}/2} L_k \exp(j2\pi k \Delta_F (t - T_{G12})) \quad (9)$$

where

$$T_{G12} = 1.6 \mu\text{s}.$$

Two periods of the long sequence are transmitted for improved channel estimation accuracy, yielding $T_{LONG} = 1.6 + 2 \times 3.2 = 8 \mu\text{s}$.

An illustration of the long training sequence generation is given in Annex G (G.3.2, Table G.5).

The sections of short repetitions and long repetitions shall be concatenated to form the preamble

$$r_{PREAMBLE}(t) = r_{SHORT}(t) + r_{LONG}(t - T_{SHORT}) \quad (10)$$

17.3.4 Signal field (SIGNAL)

The OFDM training symbols shall be followed by the SIGNAL field, which contains the RATE and the LENGTH fields of the TXVECTOR. The RATE field conveys information about the type of modulation and the coding rate as used in the rest of the packet. The encoding of the SIGNAL single OFDM symbol shall be performed with BPSK modulation of the subcarriers and using convolutional coding at $R = 1/2$. The encoding procedure, which includes convolutional encoding, interleaving, modulation mapping processes, pilot insertion, and OFDM modulation, follows the steps described in 17.3.5.5, 17.3.5.6, and 17.3.5.8, as used for transmission of data at a 6 Mbit/s rate. The contents of the SIGNAL field are not scrambled.

The SIGNAL field shall be composed of 24 bits, as illustrated in Figure 111. The four bits 0 to 3 shall encode the RATE. Bit 4 shall be reserved for future use. Bits 5–16 shall encode the LENGTH field of the TXVECTOR, with the least significant bit (LSB) being transmitted first.

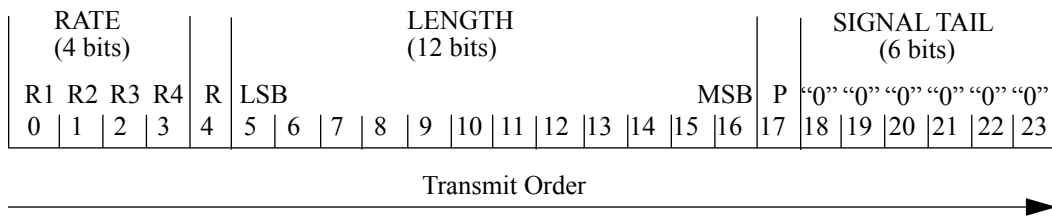

Figure 111— SIGNAL field bit assignment

The process of generating the SIGNAL OFDM symbol is illustrated in Annex G (G.4).

17.3.4.1 Data rate (RATE)

The bits R1–R4 shall be set, dependent on RATE, according to the values in Table 80.

Table 80— Contents of the SIGNAL field

Rate (Mbits/s)	R1–R4
6	1101
9	1111
12	0101
18	0111
24	1001
36	1011
48	0001
54	0011

17.3.4.2 PLCP length field (LENGTH)

The PLCP length field shall be an unsigned 12-bit integer that indicates the number of octets in the PSDU that the MAC is currently requesting the PHY to transmit. This value is used by the PHY to determine the number of octet transfers that will occur between the MAC and the PHY after receiving a request to start transmission. The transmitted value shall be determined from the LENGTH parameter in the TXVECTOR issued with the PHY-TXSTART.request primitive described in 12.3.5.4 (IEEE Std 802.11, 1999 Edition). The LSB shall be transmitted first in time. This field shall be encoded by the convolutional encoder described in 17.3.5.5.

17.3.4.3 Parity (P), Reserved (R), and Signal tail (SIGNAL TAIL)

Bit 4 shall be reserved for future use. Bit 17 shall be a positive parity (even parity) bit for bits 0–16. The bits 18–23 constitute the SIGNAL TAIL field, and all 6 bits shall be set to zero.

17.3.5 DATA field

The DATA field contains the SERVICE field, the PSDU, the TAIL bits, and the PAD bits, if needed, as described in 17.3.5.2 and 17.3.5.4. All bits in the DATA field are scrambled, as described in 17.3.5.4.

17.3.5.1 Service field (SERVICE)

The IEEE 802.11 SERVICE field has 16 bits, which shall be denoted as bits 0–15. The bit 0 shall be transmitted first in time. The bits from 0–6 of the SERVICE field, which are transmitted first, are set to zeros and are used to synchronize the descrambler in the receiver. The remaining 9 bits (7–15) of the SERVICE field shall be reserved for future use. All reserved bits shall be set to zero. Refer to Figure 112.

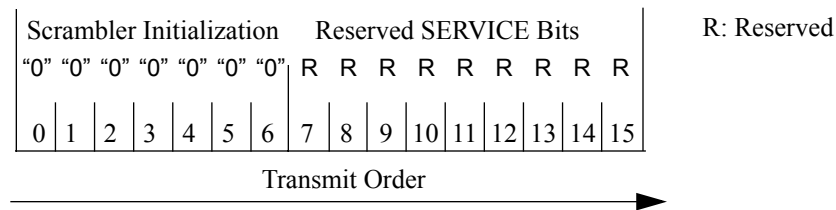

Figure 112—SERVICE field bit assignment

17.3.5.2 PPDU tail bit field (TAIL)

The PPDU tail bit field shall be six bits of “0,” which are required to return the convolutional encoder to the “zero state.” This procedure improves the error probability of the convolutional decoder, which relies on future bits when decoding and which may be not be available past the end of the message. The PLCP tail bit field shall be produced by replacing six scrambled “zero” bits following the message end with six nonscrambled “zero” bits.

17.3.5.4 Pad bits (PAD)

The number of bits in the DATA field shall be a multiple of N_{CBPS} , the number of coded bits in an OFDM symbol (48, 96, 192, or 288 bits). To achieve that, the length of the message is extended so that it becomes a multiple of N_{DBPS} , the number of data bits per OFDM symbol. At least 6 bits are appended to the message, in order to accommodate the TAIL bits, as described in 17.3.5.2. The number of OFDM symbols, N_{SYM} ; the number of bits in the DATA field, N_{DATA} ; and the number of pad bits, N_{PAD} , are computed from the length of the PSDU (LENGTH) as follows:

$$N_{SYM} = \text{Ceiling}((16 + 8 \times \text{LENGTH} + 6)/N_{DBPS}) \quad (11)$$

$$N_{DATA} = N_{SYM} \times N_{DBPS} \quad (12)$$

$$N_{PAD} = N_{DATA} - (16 + 8 \times \text{LENGTH} + 6) \quad (13)$$

The function ceiling (.) is a function that returns the smallest integer value greater than or equal to its argument value. The appended bits (“pad bits”) are set to “zeros” and are subsequently scrambled with the rest of the bits in the DATA field.

An example of a DATA field that contains the SERVICE field, DATA, tail, and pad bits is given in Annex G (G.5.1).

17.3.5.4 PLCP DATA scrambler and descrambler

The DATA field, composed of SERVICE, PSDU, tail, and pad parts, shall be scrambled with a length-127 frame-synchronous scrambler. The octets of the PSDU are placed in the transmit serial bit stream, bit 0 first and bit 7 last. The frame synchronous scrambler uses the generator polynomial $S(x)$ as follows, and is illustrated in Figure 113:

$$S(x) = x^7 + x^4 + 1 \tag{14}$$

The 127-bit sequence generated repeatedly by the scrambler shall be (leftmost used first), 00001110 11110010 11001001 00000010 00100110 00101110 10110110 00001100 11010100 11100111 10110100 00101010 11111010 01010001 10111000 11111111, when the “all ones” initial state is used. The same scrambler is used to scramble transmit data and to descramble receive data. When transmitting, the initial state of the scrambler will be set to a pseudo random non-zero state. The seven LSBs of the SERVICE field will be set to all zeros prior to scrambling to enable estimation of the initial state of the scrambler in the receiver.

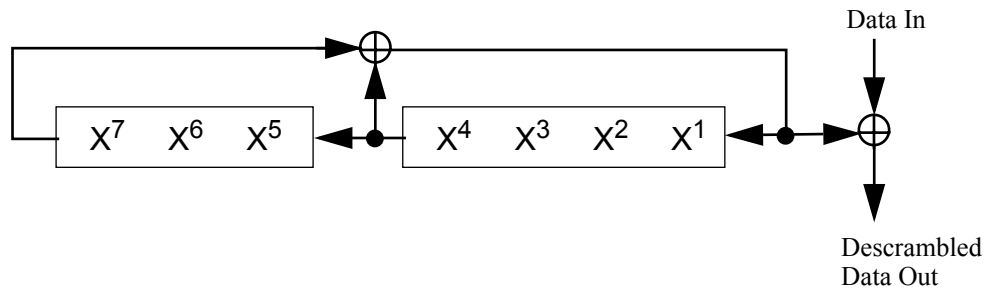

Figure 113—Data scrambler

An example of the scrambler output is illustrated in Annex G (G.5.2).

17.3.5.5 Convolutional encoder

The DATA field, composed of SERVICE, PSDU, tail, and pad parts, shall be coded with a convolutional encoder of coding rate $R = 1/2, 2/3,$ or $3/4,$ corresponding to the desired data rate. The convolutional encoder shall use the industry-standard generator polynomials, $g_0 = 133_8$ and $g_1 = 171_8,$ of rate $R = 1/2,$ as shown in Figure 114. The bit denoted as “A” shall be output from the encoder before the bit denoted as “B.” Higher rates are derived from it by employing “puncturing.” Puncturing is a procedure for omitting some of the encoded bits in the transmitter (thus reducing the number of transmitted bits and increasing the coding rate) and inserting a dummy “zero” metric into the convolutional decoder on the receive side in place of the omitted bits. The puncturing patterns are illustrated in Figure 115. Decoding by the Viterbi algorithm is recommended.

An example of encoding operation is shown in Annex G (G.6.1).

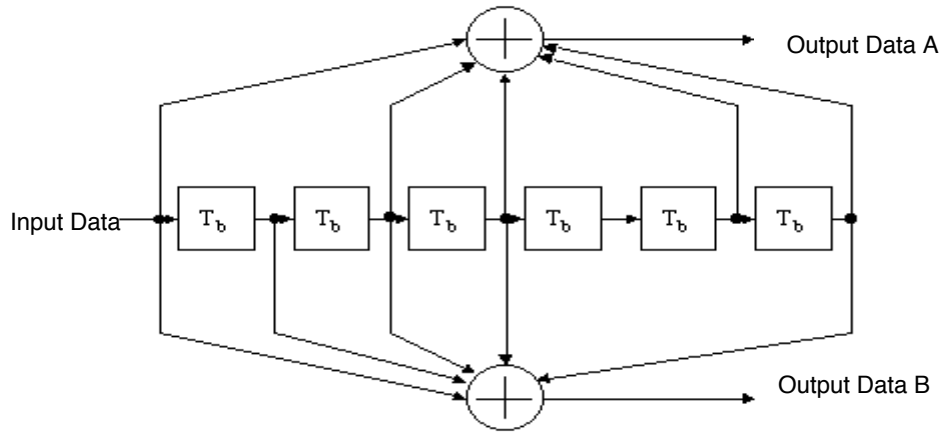

Figure 114—Convolutional encoder (k = 7)

17.3.5.6 Data interleaving

All encoded data bits shall be interleaved by a block interleaver with a block size corresponding to the number of bits in a single OFDM symbol, N_{CBPS} . The interleaver is defined by a two-step permutation. The first permutation ensures that adjacent coded bits are mapped onto nonadjacent subcarriers. The second ensures that adjacent coded bits are mapped alternately onto less and more significant bits of the constellation and, thereby, long runs of low reliability (LSB) bits are avoided.

We shall denote by k the index of the coded bit before the first permutation; i shall be the index after the first and before the second permutation, and j shall be the index after the second permutation, just prior to modulation mapping.

The first permutation is defined by the rule

$$i = (N_{CBPS}/16) (k \bmod 16) + \text{floor}(k/16) \quad k = 0, 1, \dots, N_{CBPS} - 1 \quad (15)$$

The function floor (.) denotes the largest integer not exceeding the parameter.

The second permutation is defined by the rule

$$j = s \times \text{floor}(i/s) + (i + N_{CBPS} - \text{floor}(16 \times i/N_{CBPS})) \bmod s \quad i = 0, 1, \dots, N_{CBPS} - 1 \quad (16)$$

The value of s is determined by the number of coded bits per subcarrier, N_{BPSC} , according to

$$s = \max(N_{BPSC}/2, 1) \quad (17)$$

The deinterleaver, which performs the inverse relation, is also defined by two permutations.

Punctured Coding ($r = 3/4$)

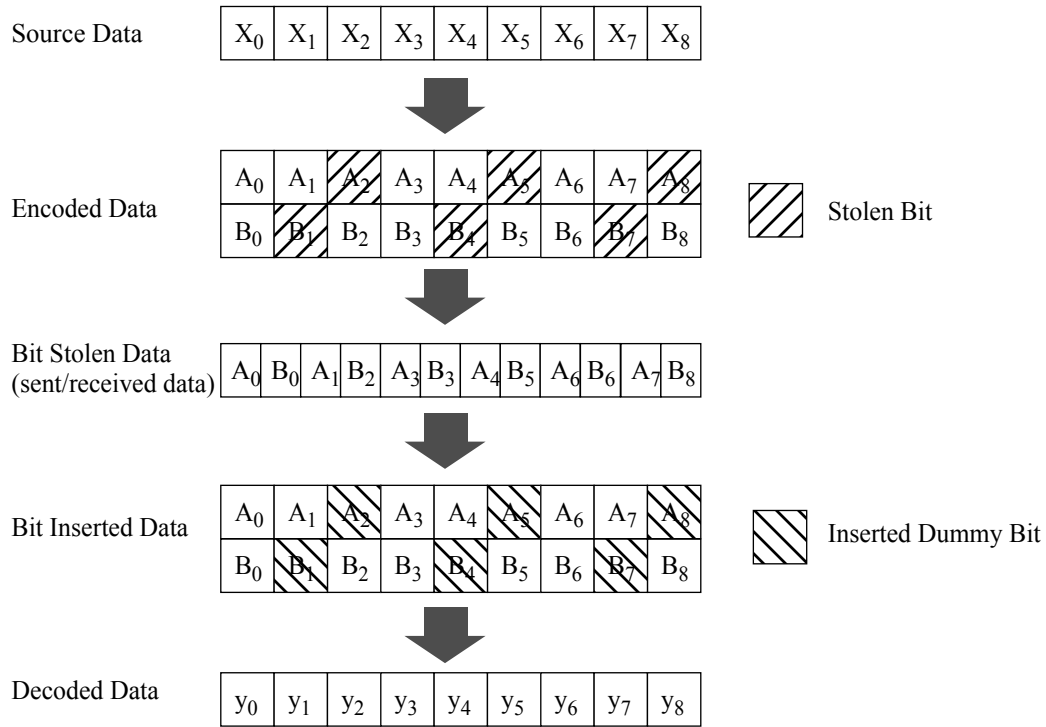

Punctured Coding ($r = 2/3$)

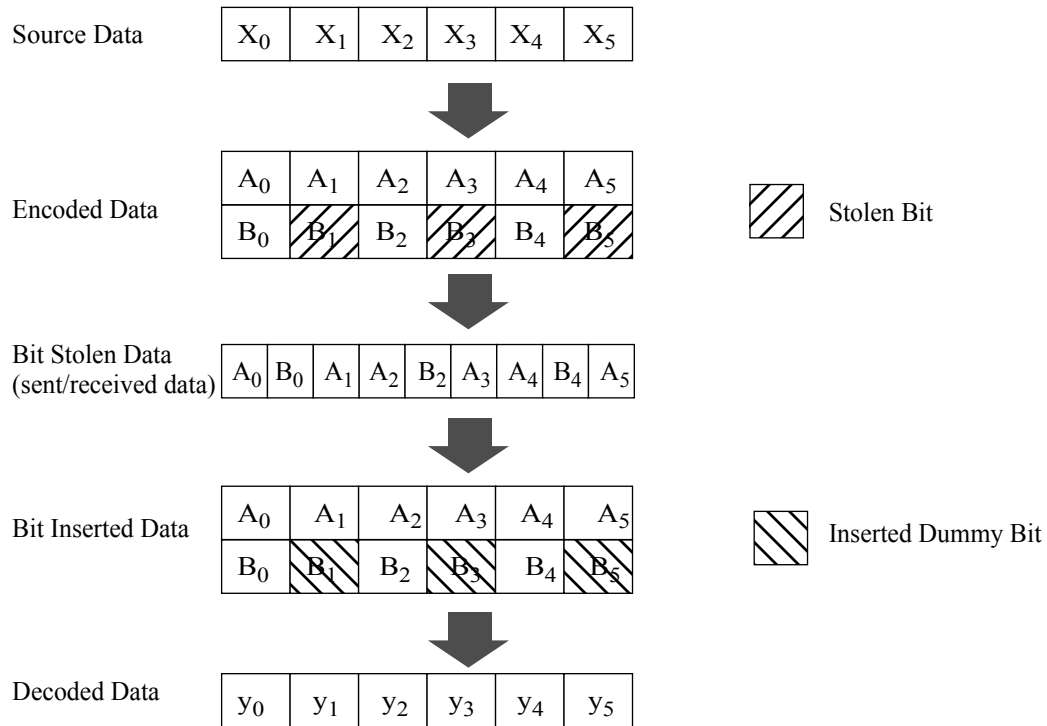

Figure 115—An example of the bit-stealing and bit-insertion procedure ($r = 3/4, 2/3$)

Here we shall denote by j the index of the original received bit before the first permutation; i shall be the index after the first and before the second permutation, and k shall be the index after the second permutation, just prior to delivering the coded bits to the convolutional (Viterbi) decoder.

The first permutation is defined by the rule

$$i = s \times \text{floor}(j/s) + (j + \text{floor}(16 \times j/N_{\text{CBPS}})) \bmod s \quad j = 0, 1, \dots, N_{\text{CBPS}} - 1 \quad (18)$$

where

s is defined in Equation (17).

This permutation is the inverse of the permutation described in Equation (16).

The second permutation is defined by the rule

$$k = 16 \times i - (N_{\text{CBPS}} - 1) \text{floor}(16 \times i/N_{\text{CBPS}}) \quad i = 0, 1, \dots, N_{\text{CBPS}} - 1 \quad (19)$$

This permutation is the inverse of the permutation described in Equation (15).

An example of interleaving operation is illustrated in Annex G (G.6.2).

17.3.5.7 Subcarrier modulation mapping

The OFDM subcarriers shall be modulated by using BPSK, QPSK, 16-QAM, or 64-QAM modulation, depending on the RATE requested. The encoded and interleaved binary serial input data shall be divided into groups of N_{BPSC} (1, 2, 4, or 6) bits and converted into complex numbers representing BPSK, QPSK, 16-QAM, or 64-QAM constellation points. The conversion shall be performed according to Gray-coded constellation mappings, illustrated in Figure 116, with the input bit, b_0 , being the earliest in the stream. The output values, d , are formed by multiplying the resulting $(I+jQ)$ value by a normalization factor K_{MOD} , as described in Equation (20).

$$d = (I + jQ) \times K_{\text{MOD}} \quad (20)$$

The normalization factor, K_{MOD} , depends on the base modulation mode, as prescribed in Table 81. Note that the modulation type can be different from the start to the end of the transmission, as the signal changes from SIGNAL to DATA, as shown in Figure 107. The purpose of the normalization factor is to achieve the same average power for all mappings. In practical implementations, an approximate value of the normalization factor can be used, as long as the device conforms with the modulation accuracy requirements described in 17.3.9.6.

Table 81 – Modulation-dependent normalization factor K_{MOD}

Modulation	K_{MOD}
BPSK	1
QPSK	$1/\sqrt{2}$
16-QAM	$1/\sqrt{10}$
64-QAM	$1/\sqrt{42}$

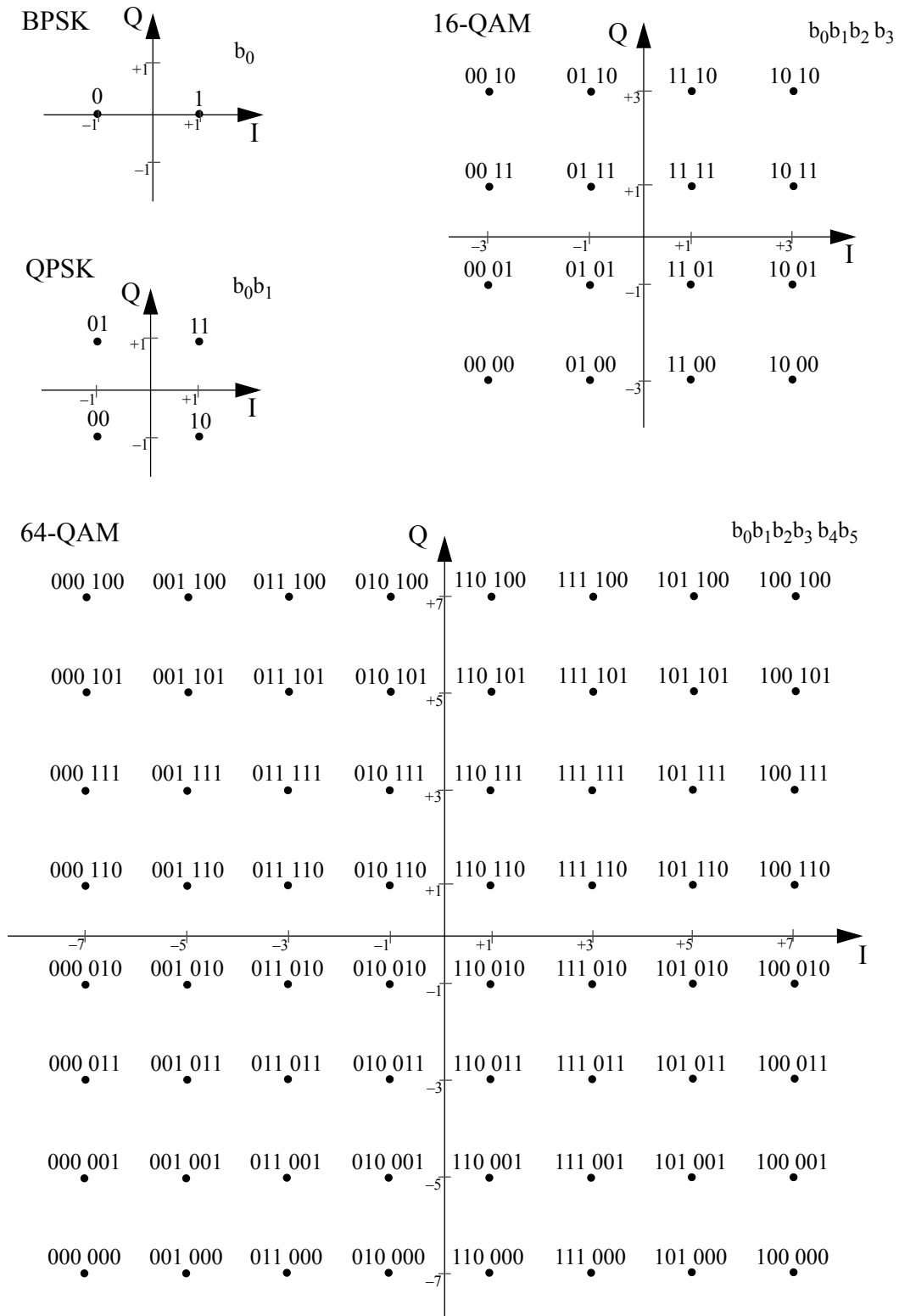

Figure 116—BPSK, QPSK, 16-QAM, and 64-QAM constellation bit encoding

For BPSK, b_0 determines the I value, as illustrated in Table 82. For QPSK, b_0 determines the I value and b_1 determines the Q value, as illustrated in Table 83. For 16-QAM, b_0b_1 determines the I value and b_2b_3 determines the Q value, as illustrated in Table 84. For 64-QAM, $b_0b_1b_2$ determines the I value and $b_3b_4b_5$ determines the Q value, as illustrated in Table 85.

Table 82—BPSK encoding table

Input bit (b_0)	I-out	Q-out
0	-1	0
1	1	0

Table 83—QPSK encoding table

Input bit (b_0)	I-out	Input bit (b_1)	Q-out
0	-1	0	-1
1	1	1	1

Table 84—16-QAM encoding table

Input bits ($b_0 b_1$)	I-out	Input bits ($b_2 b_3$)	Q-out
00	-3	00	-3
01	-1	01	-1
11	1	11	1
10	3	10	3

Table 85—64-QAM encoding table

Input bits ($b_0 b_1 b_2$)	I-out	Input bits ($b_3 b_4 b_5$)	Q-out
000	-7	000	-7
001	-5	001	-5
011	-3	011	-3
010	-1	010	-1
110	1	110	1
111	3	111	3
101	5	101	5
100	7	100	7

The polarity of the pilot subcarriers is controlled by the sequence, p_n , which is a cyclic extension of the 127 elements sequence and is given by

$$p_{0..126v} = \{1,1,1,1, -1,-1,-1,1, -1,-1,-1,-1, 1,1,-1,1, -1,-1,1,1, -1,1,1,-1, 1,1,1,1, 1,1,-1,1, \\ 1,1,-1,1, 1,-1,-1,1, 1,1,-1,1, -1,-1,-1,1, -1,1,-1,-1, 1,-1,-1,1, 1,1,1,1, -1,-1,1,1, \\ -1,-1,1,-1, 1,-1,1,1, -1,-1,-1,1, 1,-1,-1,-1, -1,1,-1,-1, 1,-1,1,1, 1,1,-1,1, -1,1,-1,1, \\ -1,-1,-1,-1, -1,1,-1,1, 1,-1,1,-1, 1,1,1,-1, -1,1,-1,-1, -1,1,1,1, -1,-1,-1,-1, -1,-1,-1\} \quad (25)$$

The sequence, p_n , can be generated by the scrambler defined by Figure 113 when the “all ones” initial state is used, and by replacing all “1’s” with -1 and all “0’s” with 1. Each sequence element is used for one OFDM symbol. The first element, p_0 , multiplies the pilot subcarriers of the SIGNAL symbol, while the elements from p_1 on are used for the DATA symbols.

The subcarrier frequency allocation is shown in Figure 117. To avoid difficulties in D/A and A/D converter offsets and carrier feedthrough in the RF system, the subcarrier falling at DC (0^{th} subcarrier) is not used.

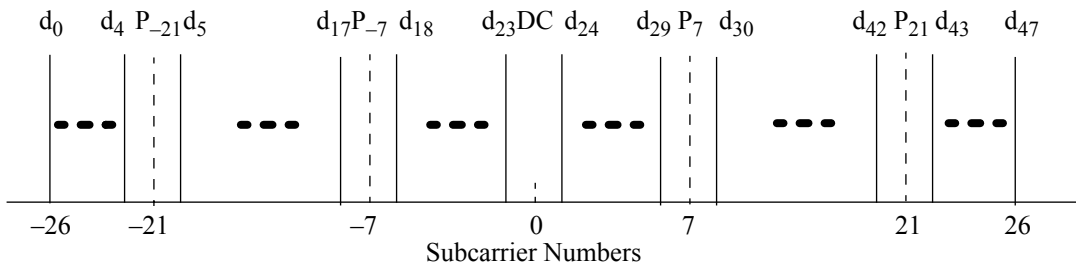

Figure 117—Subcarrier frequency allocation

The concatenation of N_{SYM} OFDM symbols can now be written as

$$r_{DATA}(t) = \sum_{n=0}^{N_{SYM}-1} r_{DATA,n}(t - nT_{SYM}) \quad (26)$$

An example of mapping into symbols is shown in Annex G (G.6.3), as well as the scrambling of the pilot signals (G.7). The final output of these operations is also shown in Annex G (G.8).

17.3.6 Clear channel assessment (CCA)

PLCP shall provide the capability to perform CCA and report the result to the MAC. The CCA mechanism shall detect a “medium busy” condition with a performance specified in 17.3.10.5. This medium status report is indicated by the primitive PHY_CCA.indicate.

17.3.7 PLCP data modulation and modulation rate change

The PLCP preamble shall be transmitted using an OFDM modulated fixed waveform. The IEEE 802.11 SIGNAL field, BPSK-OFDM modulated at 6 Mbit/s, shall indicate the modulation and coding rate that shall be used to transmit the MPDU. The transmitter (receiver) shall initiate the modulation (demodulation) constellation and the coding rate according to the RATE indicated in the SIGNAL field. The MPDU transmission rate shall be set by the DATARATE parameter in the TXVECTOR, issued with the PHY_TXSTART.request primitive described in 17.2.2.

17.3.8 PMD operating specifications (general)

Subclauses 17.3.8.1 through 17.3.8.8 provide general specifications for the BPSK OFDM, QPSK OFDM, 16-QAM OFDM, and 64-QAM OFDM PMD sublayers. These specifications apply to both the receive and transmit functions and general operation of the OFDM PHY.

17.3.8.1 Outline description

The general block diagram of the transmitter and receiver for the OFDM PHY is shown in Figure 118. Major specifications for the OFDM PHY are listed in Table 86.

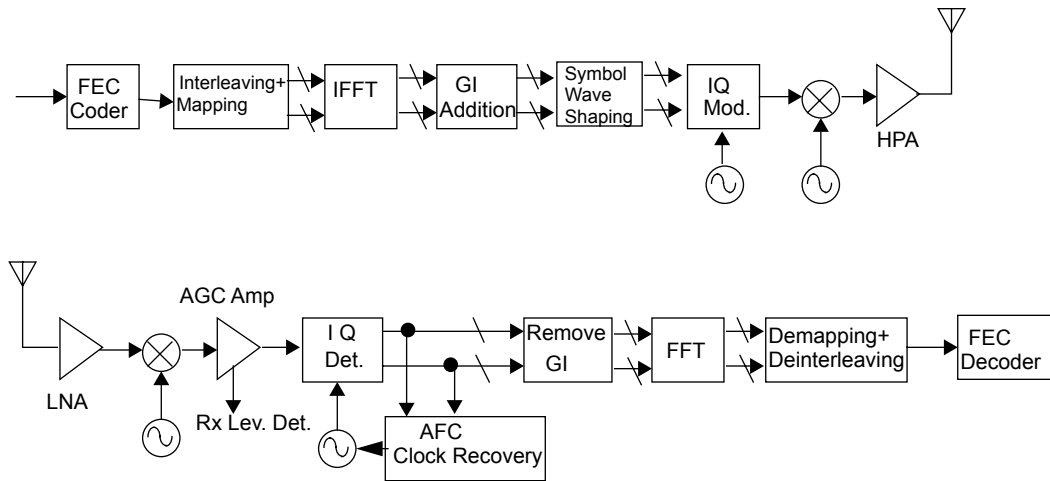

Figure 118— Transmitter and receiver block diagram for the OFDM PHY

Table 86— Major parameters of the OFDM PHY

Information data rate	6, 9, 12, 18, 24, 36, 48 and 54 Mbit/s (6, 12 and 24 Mbit/s are mandatory)
Modulation	BPSK OFDM QPSK OFDM 16-QAM OFDM 64-QAM OFDM
Error correcting code	K = 7 (64 states) convolutional code
Coding rate	1/2, 2/3, 3/4
Number of subcarriers	52
OFDM symbol duration	4.0 μ s
Guard interval	0.8 μ s ^a (T_{GI})
Occupied bandwidth	16.6 MHz

^aRefer to 17.3.2.4.

17.3.8.2 Regulatory requirements

Wireless LANs implemented in accordance with this standard are subject to equipment certification and operating requirements established by regional and national regulatory administrations. The PMD specification establishes minimum technical requirements for interoperability, based upon established regulations at the time this standard was issued. These regulations are subject to revision, or may be superseded. Requirements that are subject to local geographic regulations are annotated within the PMD specification. Regulatory requirements that do not affect interoperability are not addressed in this standard. Implementors are referred to the regulatory sources in Table 87 for further information. Operation in countries within defined regulatory domains may be subject to additional or alternative national regulations.

The documents listed in Table 87 specify the current regulatory requirements for various geographic areas at the time this standard was developed. They are provided for information only, and are subject to change or revision at any time.

Table 87—Regulatory requirement list

Geographic area	Approval standards	Documents	Approval authority
United States	Federal Communications Commission (FCC)	CFR47, Part 15, sections 15.205 and 15.209; and Subpart E, sections 15.401–15.407	FCC
Japan	Ministry of Post and Telecommunication (MPT)	MPT Ordinance for Regulating Radio Equipment, Article 49.20	MPT

17.3.8.3 Operating channel frequencies

17.3.8.3.1 Operating frequency range

The OFDM PHY shall operate in the 5 GHz band, as allocated by a regulatory body in its operational region. Spectrum allocation in the 5 GHz band is subject to authorities responsible for geographic-specific regulatory domains (e.g., global, regional, and national). The particular channelization to be used for this standard is dependent on such allocation, as well as the associated regulations for use of the allocations. These regulations are subject to revision, or may be superseded. In the United States, the FCC is the agency responsible for the allocation of the 5 GHz U-NII bands.

In some regulatory domains, several frequency bands may be available for OFDM PHY-based wireless LANs. These bands may be contiguous or not, and different regulatory limits may be applicable. A compliant OFDM PHY shall support at least one frequency band in at least one regulatory domain. The support of specific regulatory domains, and bands within the domains, shall be indicated by PLME attributes dot11 RegDomainsSupported and dot11 FrequencyBandsSupported.

17.3.8.3.2 Channel numbering

Channel center frequencies are defined at every integral multiple of 5 MHz above 5 GHz. The relationship between center frequency and channel number is given by the following equation:

$$\text{Channel center frequency} = 5000 + 5 \times n_{\text{ch}} \text{ (MHz)} \quad (1)$$

where

$$n_{\text{ch}} = 0, 1, \dots, 200.$$

This definition provides a unique numbering system for all channels with 5 MHz spacing from 5 GHz to 6 GHz, as well as the flexibility to define channelization sets for all current and future regulatory domains.

17.3.8.3.3 Channelization

The set of valid operating channel numbers by regulatory domain is defined in Table 88.

Table 88—Valid operating channel numbers by regulatory domain and band

Regulatory domain	Band (GHz)	Operating channel numbers	Channel center frequencies (MHz)
United States	U-NII lower band (5.15–5.25)	36	5180
		40	5200
		44	5220
		48	5240
United States	U-NII middle band (5.25–5.35)	52	5260
		56	5280
		60	5300
		64	5320
United States	U-NII upper band (5.725–5.825)	149	5745
		153	5765
		157	5785
		161	5805

Figure 119 shows the channelization scheme for this standard, which shall be used with the FCC U-NII frequency allocation. The lower and middle U-NII sub-bands accommodate eight channels in a total bandwidth of 200 MHz. The upper U-NII band accommodates four channels in a 100 MHz bandwidth. The centers of the outermost channels shall be at a distance of 30 MHz from the band's edges for the lower and middle U-NII bands, and 20 MHz for the upper U-NII band.

The OFDM PHY shall operate in the 5 GHz band, as allocated by a regulatory body in its operational region.

The center frequency is indicated in Figure 119; however, no subcarrier is allocated on the center frequency as described in Figure 117.

In a multiple cell network topology, overlapping and/or adjacent cells using different channels can operate simultaneously.

17.3.8.4 Transmit and receive in-band and out-of-band spurious emissions

The OFDM PHY shall conform to in-band and out-of-band spurious emissions as set by regulatory bodies. For the United States, refer to FCC 15.407.

17.3.8.5 TX RF delay

The TX RF delay time shall be defined as the time between the issuance of a PMD.DATA.request to the PMD and the start of the corresponding symbol at the air interface.

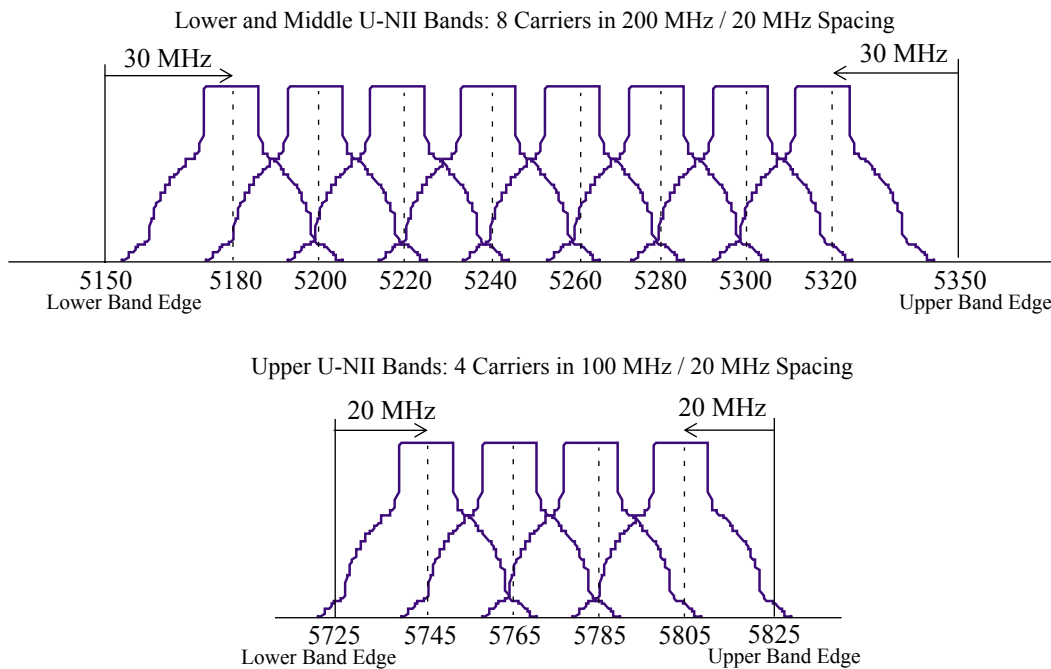

Figure 119—OFDM PHY frequency channel plan for the United States

17.3.8.6 Slot time

The slot time for the OFDM PHY shall be 9 μ s, which is the sum of the RX-to-TX turnaround time, MAC processing delay, and CCA detect time (< 4 μ s). The propagation delay shall be regarded as being included in the CCA detect time.

17.3.8.7 Transmit and receive antenna port impedance

The transmit and receive antenna port(s) impedance shall be 50 Ω if the port is exposed.

17.3.8.8 Transmit and receive operating temperature range

Three temperature ranges for full operation compliance to the OFDM PHY are specified in Clause 13 of IEEE Std 802.11, 1999 Edition. Type 1, defined as 0 $^{\circ}$ C to 40 $^{\circ}$ C, is designated for office environments. Type 2, defined as -20 $^{\circ}$ C to 50 $^{\circ}$ C, and Type 3, defined as -30 $^{\circ}$ C to 70 $^{\circ}$ C, are designated for industrial environments.

17.3.9 PMD transmit specifications

Subclauses 17.3.9.1 through 17.3.9.7 describe the transmit specifications associated with the PMD sublayer. In general, these are specified by primitives from the PLCP, and the transmit PMD entity provides the actual means by which the signals required by the PLCP primitives are imposed onto the medium.

17.3.9.1 Transmit power levels

The maximum allowable output power according to FCC regulations is shown in Table 89.

Table 89—Transmit power levels for the United States

Frequency band (GHz)	Maximum output power with up to 6 dBi antenna gain (mW)
5.15–5.25	40 (2.5 mW/MHz)
5.25–5.35	200 (12.5 mW/MHz)
5.725–5.825	800 (50 mW/MHz)

17.3.9.2 Transmit spectrum mask

The transmitted spectrum shall have a 0 dBr (dB relative to the maximum spectral density of the signal) bandwidth not exceeding 18 MHz, -20 dBr at 11 MHz frequency offset, -28 dBr at 20 MHz frequency offset and -40 dBr at 30 MHz frequency offset and above. The transmitted spectral density of the transmitted signal shall fall within the spectral mask, as shown in Figure 120. The measurements shall be made using a 100 kHz resolution bandwidth and a 30 kHz video bandwidth.

17.3.9.3 Transmission spurious

Spurious transmissions from compliant devices shall conform to national regulations.

17.3.9.4 Transmit center frequency tolerance

The transmitted center frequency tolerance shall be ± 20 ppm maximum. The transmit center frequency and the symbol clock frequency shall be derived from the same reference oscillator.

17.3.9.5 Symbol clock frequency tolerance

The symbol clock frequency tolerance shall be ± 20 ppm maximum. The transmit center frequency and the symbol clock frequency shall be derived from the same reference oscillator.

17.3.9.6 Modulation accuracy

Transmit modulation accuracy specifications are described in this subclause. The test method is described in 17.3.9.7.

17.3.9.6.1 Transmitter center frequency leakage

Certain transmitter implementations may cause leakage of the center frequency component. Such leakage (which manifests itself in a receiver as energy in the center frequency component) shall not exceed -15 dB relative to overall transmitted power or, equivalently, +2 dB relative to the average energy of the rest of the subcarriers. The data for this test shall be derived from the channel estimation phase.

17.3.9.6.2 Transmitter spectral flatness

The average energy of the constellations in each of the spectral lines -16.. -1 and +1.. +16 will deviate no more than ± 2 dB from their average energy. The average energy of the constellations in each of the spectral lines -26.. -17 and +17.. +26 will deviate no more than +2/-4 dB from the average energy of spectral lines -16.. -1 and +1.. +16. The data for this test shall be derived from the channel estimation step.

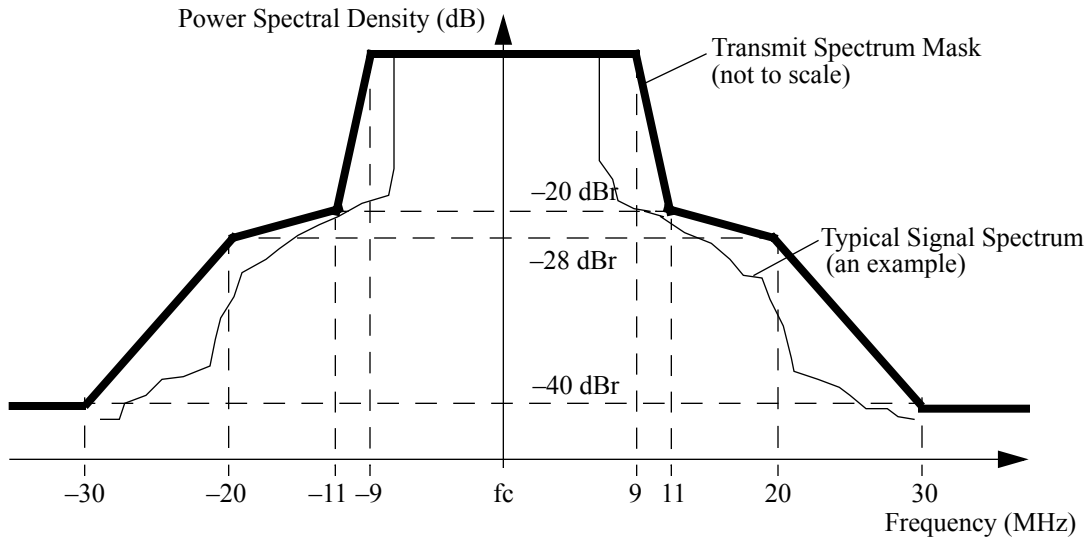

Figure 120—Transmit spectrum mask

17.3.9.6.3 Transmitter constellation error

The relative constellation RMS error, averaged over subcarriers, OFDM frames, and packets, shall not exceed a data-rate dependent value according to Table 90.

Table 90—Allowed relative constellation error versus data rate

Data rate (Mbits/s)	Relative constellation error (dB)
6	-5
9	-8
12	-10
18	-13
24	-16
36	-19
48	-22
54	-25

17.3.9.7 Transmit modulation accuracy test

The transmit modulation accuracy test shall be performed by instrumentation capable of converting the transmitted signal into a stream of complex samples at 20 Msamples/s or more, with sufficient accuracy in terms of I/Q arm amplitude and phase balance, dc offsets, phase noise, etc. A possible embodiment of such a setup is converting the signal to a low IF frequency with a microwave synthesizer, sampling the signal with a digital oscilloscope and decomposing it digitally into quadrature components.

The sampled signal shall be processed in a manner similar to an actual receiver, according to the following steps, or an equivalent procedure:

- a) Start of frame shall be detected.
- b) Transition from short sequences to channel estimation sequences shall be detected, and fine timing (with one sample resolution) shall be established.
- c) Coarse and fine frequency offsets shall be estimated.
- d) The packet shall be derotated according to estimated frequency offset.
- e) The complex channel response coefficients shall be estimated for each of the subcarriers.
- f) For each of the data OFDM symbols: transform the symbol into subcarrier received values, estimate the phase from the pilot subcarriers, derotate the subcarrier values according to estimated phase, and divide each subcarrier value with a complex estimated channel response coefficient.
- g) For each data-carrying subcarrier, find the closest constellation point and compute the Euclidean distance from it.
- h) Compute the RMS average of all errors in a packet. It is given by:

$$Error_{RMS} = \frac{\sum_{i=1}^{N_f} \sqrt{\frac{\sum_{j=1}^{L_p} \left[\sum_{k=1}^{52} \{ (I(i, j, k) - I_0(i, j, k))^2 + (Q(i, j, k) - Q_0(i, j, k))^2 \} \right]}{52L_p \times P_0}}}{N_f} \quad (28)$$

where

L_p is the length of the packet;

N_f is the number of frames for the measurement;

$(I_0(i, j, k), Q_0(i, j, k))$ denotes the ideal symbol point of the i^{th} frame, j^{th} OFDM symbol of the frame, k^{th} subcarrier of the OFDM symbol in the complex plane;

$(I(i, j, k), Q(i, j, k))$ denotes the observed point of the i^{th} frame, j^{th} OFDM symbol of the frame, k^{th} subcarrier of the OFDM symbol in the complex plane (see Figure 121);

P_0 is the average power of the constellation.

The vector error on a phase plane is shown in Figure 121.

The test shall be performed over at least 20 frames (N_f), and the RMS average shall be taken. The packets under test shall be at least 16 OFDM symbols long. Random data shall be used for the symbols.

17.3.10 PMD receiver specifications

Subclauses 17.3.10.1 through 17.3.10.5 describe the receive specifications associated with the PMD sublayer.

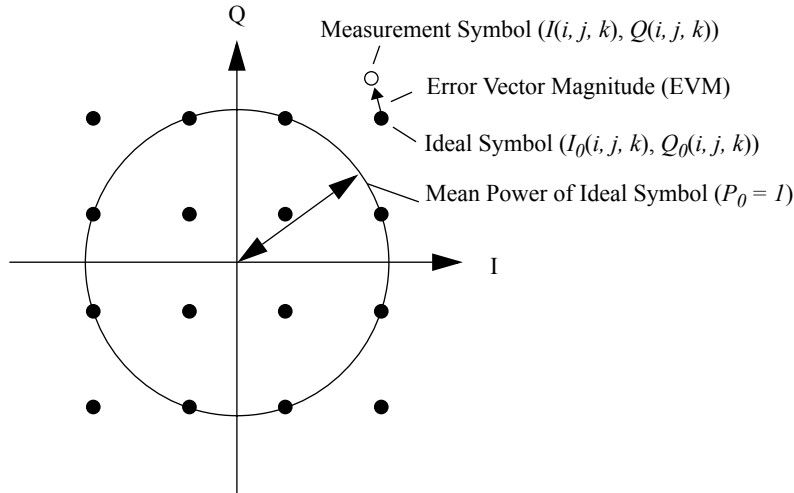

Figure 121—Constellation error

17.3.10.1 Receiver minimum input level sensitivity

The packet error rate (PER) shall be less than 10% at a PSDU length of 1000 bytes for rate-dependent input levels shall be the numbers listed in Table 91 or less. The minimum input levels are measured at the antenna connector (NF of 10 dB and 5 dB implementation margins are assumed).

Table 91—Receiver performance requirements

Data rate (Mbits/s)	Minimum sensitivity (dBm)	Adjacent channel rejection (dB)	Alternate adjacent channel rejection (dB)
6	-82	16	32
9	-81	15	31
12	-79	13	29
18	-77	11	27
24	-74	8	24
36	-70	4	20
48	-66	0	16
54	-65	-1	15

17.3.10.2 Adjacent channel rejection

The adjacent channel rejection shall be measured by setting the desired signal's strength 3 dB above the rate-dependent sensitivity specified in Table 91 and raising the power of the interfering signal until 10% PER is caused for a PSDU length of 1000 bytes. The power difference between the interfering and the desired channel is the corresponding adjacent channel rejection. The interfering signal in the adjacent channel shall

be a conformant OFDM signal, unsynchronized with the signal in the channel under test. For a conformant OFDM PHY the corresponding rejection shall be no less than specified in Table 91.

17.3.10.3 Non-adjacent channel rejection

The non-adjacent channel rejection shall be measured by setting the desired signal's strength 3 dB above the rate-dependent sensitivity specified in Table 91, and raising the power of the interfering signal until a 10% PER occurs for a PSDU length of 1000 bytes. The power difference between the interfering and the desired channel is the corresponding non-adjacent channel rejection. The interfering signal in the non-adjacent channel shall be a conformant OFDM signal, unsynchronized with the signal in the channel under test. For a conformed OFDM PHY, the corresponding rejection shall be no less than specified in Table 91.

17.3.10.4 Receiver maximum input level

The receiver shall provide a maximum PER of 10% at a PSDU length of 1000 bytes, for a maximum input level of -30 dBm measured at the antenna for any baseband modulation.

17.3.10.5 CCA sensitivity

The start of a valid OFDM transmission at a receive level equal to or greater than the minimum 6 Mbit/s sensitivity (-82 dBm) shall cause CCA to indicate busy with a probability $>90\%$ within 4 μ s. If the preamble portion was missed, the receiver shall hold the carrier sense (CS) signal busy for any signal 20 dB above the minimum 6 Mbit/s sensitivity (-62 dBm).

17.3.11 PLCP transmit procedure

The PLCP transmit procedure is shown in Figure 122. In order to transmit data, PHY-TXSTART.request shall be enabled so that the PHY entity shall be in the transmit state. Further, the PHY shall be set to operate at the appropriate frequency through station management via the PLME. Other transmit parameters, such as DATARATE and TX power, are set via the PHY-SAP with the PHY-TXSTART.request(TXVECTOR), as described in 17.2.2.

A clear channel shall be indicated by PHY-CCA.indicate (IDLE). The MAC considers this indication before issuing the PHY-TXSTART.request. Transmission of the PPDU shall be initiated after receiving the PHY-TXSTART.request (TXVECTOR) primitive. The TXVECTOR elements for the PHY-TXSTART.request are the PLCP header parameters DATARATE, SERVICE, and LENGTH, and the PMD parameter TXPWR_LEVEL.

The PLCP shall issue PMD_TXPWRLVL and PMD_RATE primitives to configure the PHY. The PLCP shall then issue a PMD_TXSTART.request, and transmission of the PLCP preamble and PLCP header, based on the parameters passed in the PHY-TXSTART.request primitive. Once PLCP preamble transmission is started, the PHY entity shall immediately initiate data scrambling and data encoding. The scrambled and encoded data shall then be exchanged between the MAC and the PHY through a series of PHY-DATA.request (DATA) primitives issued by the MAC, and PHY-DATA.confirm primitives issued by the PHY. The modulation rate change, if any, shall be initiated from the SERVICE field data of the PLCP header, as described in 17.3.2.

The PHY proceeds with PSDU transmission through a series of data octet transfers from the MAC. The PLCP header parameter, SERVICE, and PSDU are encoded by the convolutional encoder with the bit-stealing function described in 17.3.5.5. At the PMD layer, the data octets are sent in bit 0–7 order and presented to the PHY layer through PMD_DATA.request primitives. Transmission can be prematurely terminated by the MAC through the primitive PHY-TXEND.request. PHY-TXSTART shall be disabled by the issuance of the PHY-TXEND.request. Normal termination occurs after the transmission of the final bit of the last PSDU octet, according to the number supplied in the OFDM PHY preamble LENGTH field.

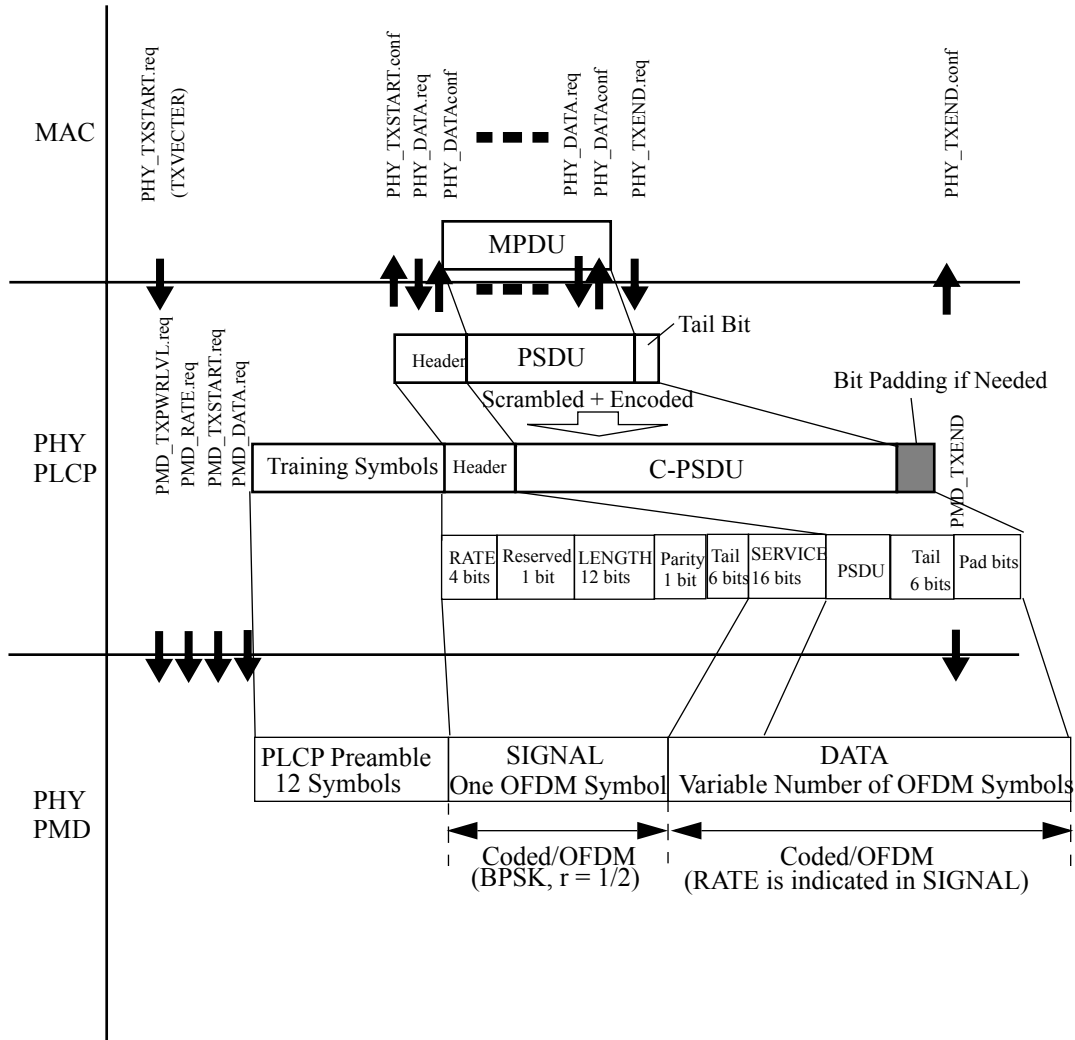

Figure 122—PLCP transmit procedure

The packet transmission shall be completed and the PHY entity shall enter the receive state (i.e., PHY-TXSTART shall be disabled). Each PHY-TXEND.request is acknowledged with a PHY-TXEND.confirm primitive from the PHY. If the coded PSDU (CPSDU) is not multiples of the OFDM symbol, bits shall be stuffed to make the CPSDU length multiples of the OFDM symbol.

In the PMD, the GI shall be inserted in every OFDM symbol as a countermeasure against severe delay spread.

A typical state machine implementation of the PLCP transmit procedure is provided in Figure 123. Requests (.req) and confirmations(.confirm) are issued once with designated states.

17.3.12 PLCP receive procedure

The PLCP receive procedure is shown in Figure 124. In order to receive data, PHY-TXSTART.request shall be disabled so that the PHY entity is in the receive state. Further, through station management (via the

PLME) the PHY is set to the appropriate frequency. Other receive parameters, such as RSSI and indicated DATARATE, may be accessed via the PHY-SAP.

Upon receiving the transmitted PLCP preamble, PMD_RSSI.indicate shall report a significant received signal strength level to the PLCP. This indicates activity to the MAC via PHY_CCA.indicate. PHY_CCA.indicate (BUSY) shall be issued for reception of a signal prior to correct reception of the PLCP frame. The PMD primitive PMD_RSSI is issued to update the RSSI and parameter reported to the MAC.

After PHY-CCA.indicate is issued, the PHY entity shall begin receiving the training symbols and searching for the SIGNAL in order to set the length of the data stream, the demodulation type, and the decoding rate. Once the SIGNAL is detected, without any errors detected by a single parity (even), FEC decode shall be initiated and the PLCP IEEE 802.11 SERVICE fields and data shall be received, decoded (a Viterbi decoder is recommended), and checked by ITU-T CRC-32. If the FCS by the ITU-T CRC-32 check fails, the PHY receiver shall return to the RX IDLE state, as depicted in Figure 124. Should the status of CCA return to the IDLE state during reception prior to completion of the full PLCP processing, the PHY receiver shall return to the RX IDLE state.

If the PLCP header reception is successful (and the SIGNAL field is completely recognizable and supported), a PHY-RXSTART.indicate(RXVECTOR) shall be issued. The RXVECTOR associated with this primitive includes the SIGNAL field, the SERVICE field, the PSDU length in bytes, and the RSSI. Also, in this case, the OFDM PHY will ensure that the CCA shall indicate a busy medium for the intended duration of the transmitted frame, as indicated by the LENGTH field.

The received PSDU bits are assembled into octets, decoded, and presented to the MAC using a series of PHY-DATA.indicate(DATA) primitive exchanges. The rate change indicated in the IEEE 802.11 SIGNAL field shall be initiated from the SERVICE field data of the PLCP header, as described in 17.3.2. The PHY shall proceed with PSDU reception. After the reception of the final bit of the last PSDU octet indicated by the PLCP preamble LENGTH field, the receiver shall be returned to the RX IDLE state, as shown in Figure 124. A PHY-RXEND.indicate (NoError) primitive shall be issued.

In the event that a change in the RSSI causes the status of the CCA to return to the IDLE state before the complete reception of the PSDU, as indicated by the PLCP LENGTH field, the error condition PHY-RXEND.indicate(CarrierLost) shall be reported to the MAC. The OFDM PHY will ensure that the CCA indicates a busy medium for the intended duration of the transmitted packet.

If the indicated rate in the SIGNAL field is not receivable, a PHY-RXSTART.indicate will not be issued. The PHY shall issue the error condition PHY-RXEND.indicate(UnsupportedRate). If the PLCP header is receivable, but the parity check of the PLCP header is not valid, a PHY-RXSTART.indicate will not be issued. The PHY shall issue the error condition PHY-RXEND.indicate(FormatViolation).

Any data received after the indicated data length are considered pad bits (to fill out an OFDM symbol) and should be discarded.

A typical state machine implementation of the PLCP receive procedure is given in Figure 125.

17.4 OFDM PLME

17.4.1 PLME_SAP sublayer management primitives

Table 92 lists the MIB attributes that may be accessed by the PHY sublayer entities and the intralayer of higher layer management entities (LMEs). These attributes are accessed via the PLME-GET, PLME-SET, PLME-RESET, and PLME-CHARACTERISTICS primitives defined in 10.4.

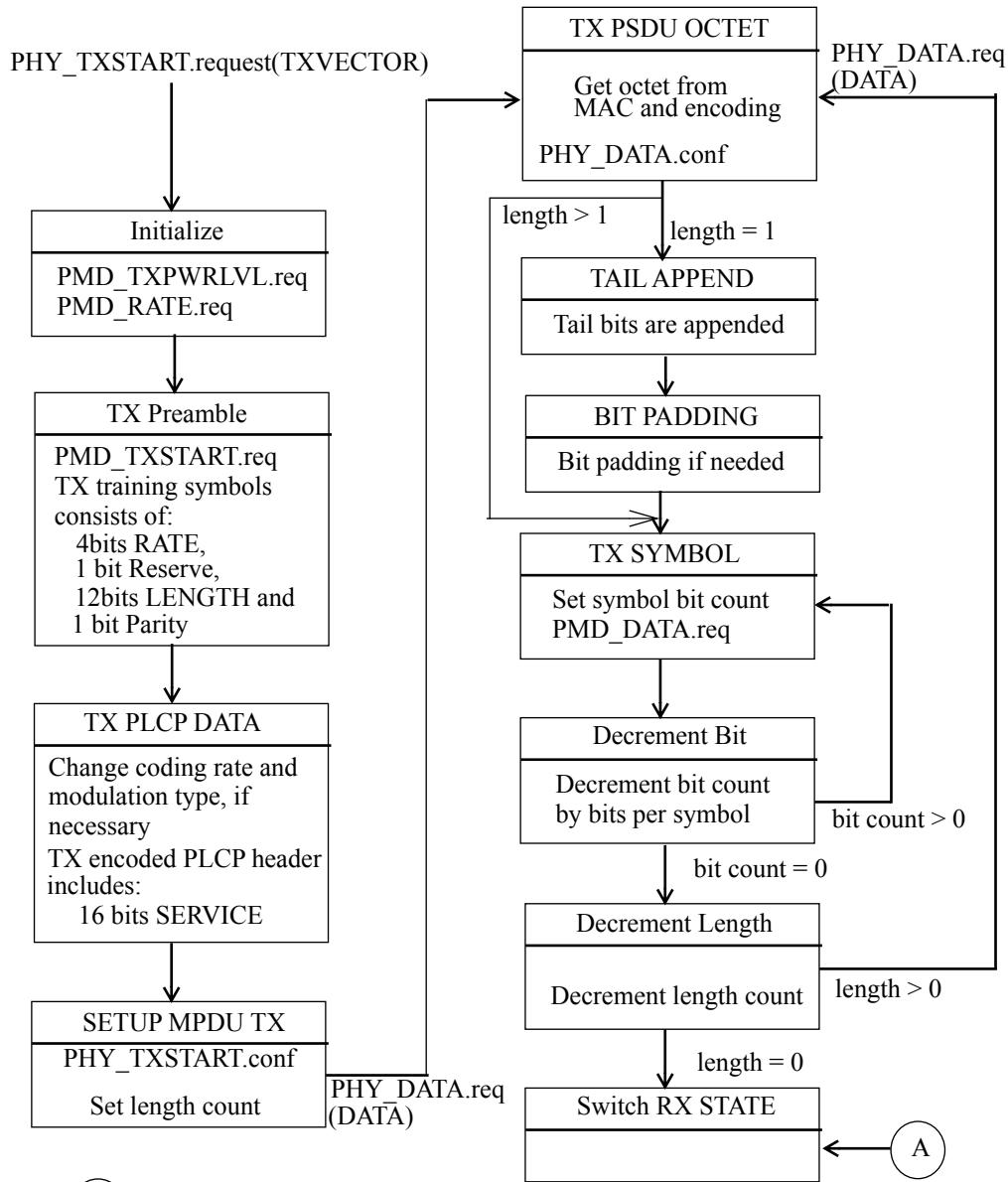

(A) At any stage in the above flow diagram, if a PHY_TXEND.request is received.

Figure 123—PLCP transmit state machine

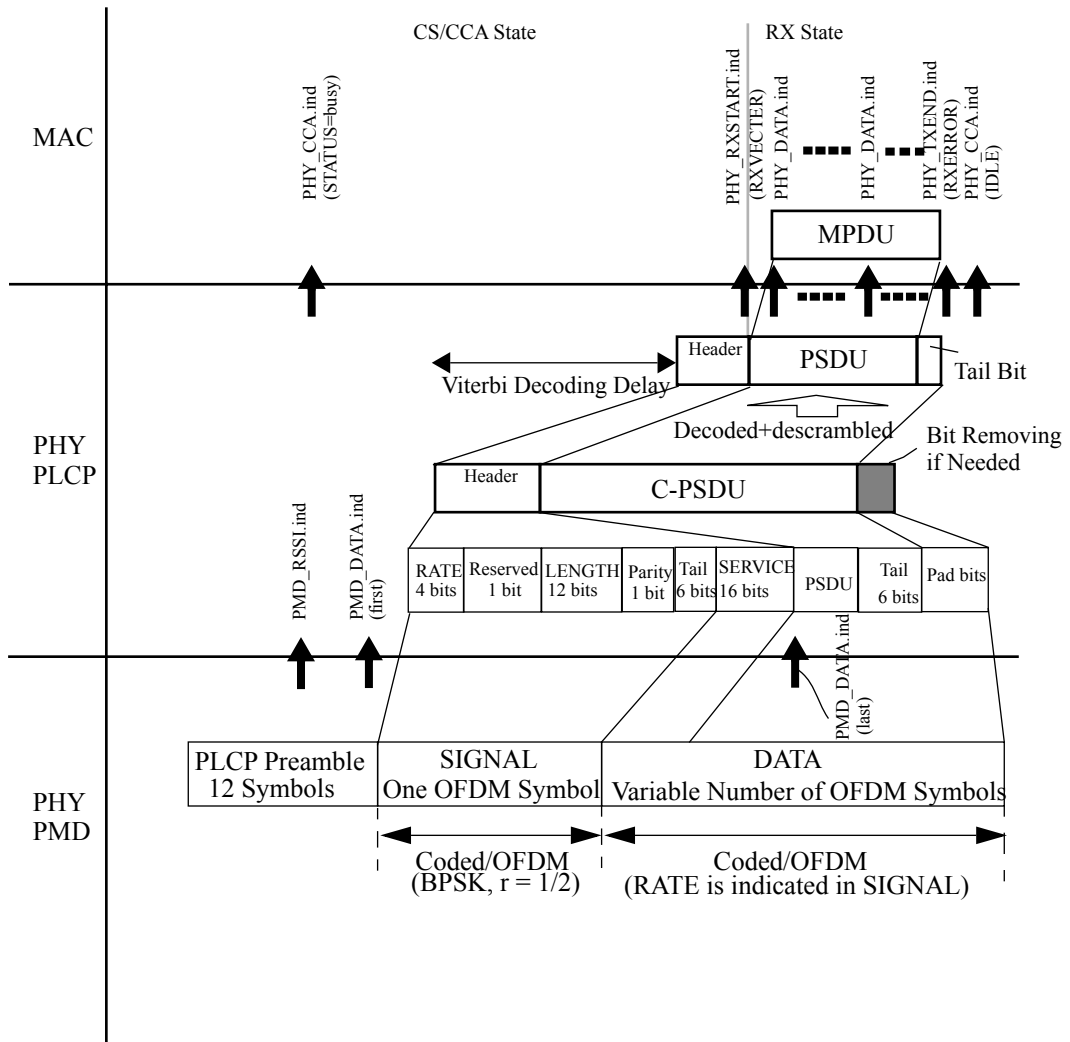

Figure 124—PLCP receive procedure

17.4.2 OFDM PHY management information base

All OFDM PHY management information base attributes are defined in Clause 13 of IEEE Std 802.11, 1999 Edition, with specific values defined in Table 92. The column titled “Operational semantics” in Table 92 contains two types: static and dynamic. Static MIB attributes are fixed and cannot be modified for a given PHY implementation. Dynamic MIB attributes can be modified by some management entity.

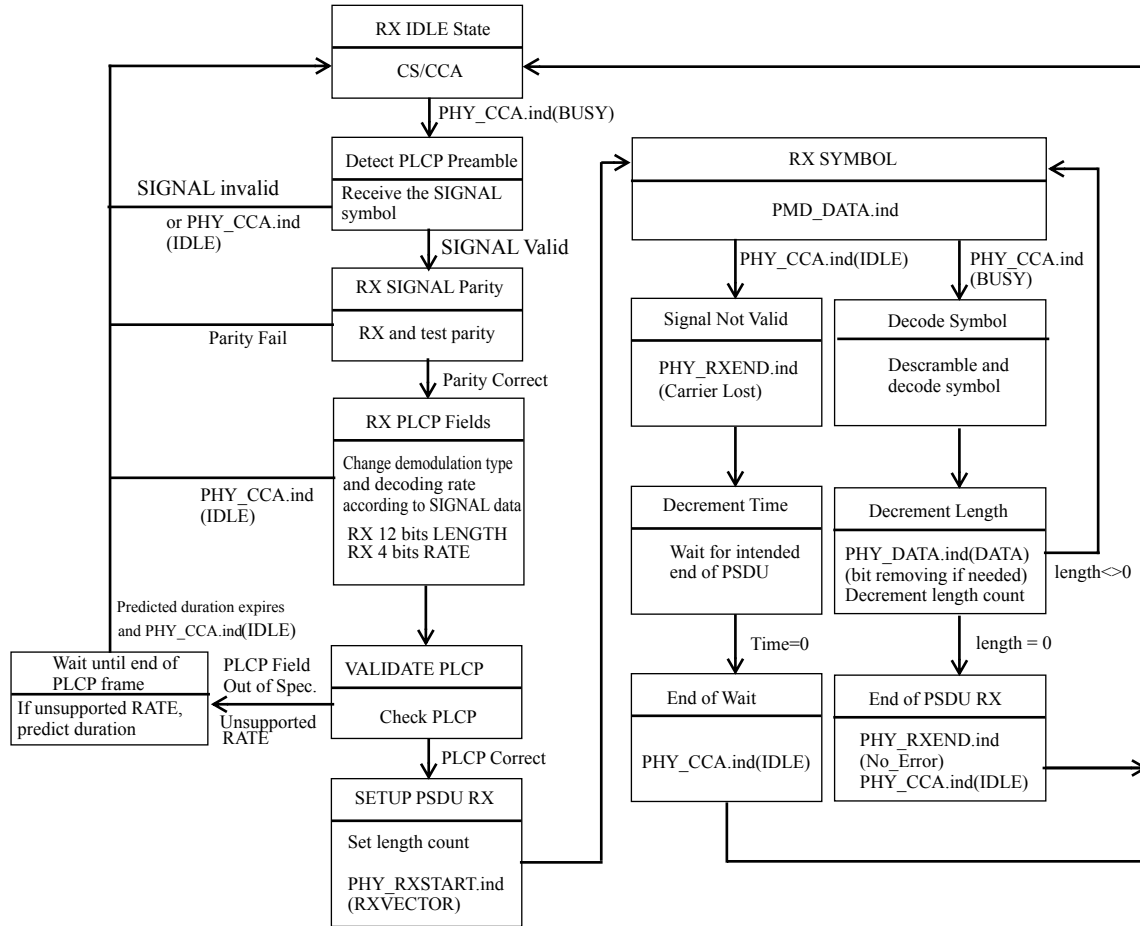

Figure 125—PLCP receive state machine

17.4.3 .OFDM TXTIME calculation

The value of the TXTIME parameter returned by the PLME-TXTIME.confirm primitive shall be calculated according to the following equation:

$$TXTIME = T_{PREMABLE} + T_{SIGNAL} + T_{SYM} \times \text{Ceiling}((16 + 8 \times LENGTH + 6)/N_{DBPS}) \tag{29}$$

where

- N_{DBPS} is derived from the DATARATE parameter. (Ceiling is a function that returns the smallest integer value greater than or equal to its argument value.)
- N_{SYM} is given by Equation (11).

Table 92—MIB attribute default values/ranges

Managed object	Default value/range	Operational semantics
dot11 PHY Operation Table		
dot11 PHY type	OFDM-5. (04)	Static
dot11 Current reg domain	Implementation dependent	Static
dot11 Current frequency band	Implementation dependent	Dynamic
dot11 Temp type	Implementation dependent	Static
dot11 PHY Antenna Table		
dot11 Current Tx antenna	Implementation dependent	Dynamic
dot11 Diversity support	Implementation dependent	Static
dot11 Current Rx antenna	Implementation dependent	Dynamic
dot11 PHY Tx Power Table		
dot11 Number supported power levels	Implementation dependent	Static
dot11 Tx power level 1	Implementation dependent	Static
dot11 Tx power level 2	Implementation dependent	Static
dot11 Tx power level 3	Implementation dependent	Static
dot11 Tx power level 4	Implementation dependent	Static
dot11 Tx power level 5	Implementation dependent	Static
dot11 Tx power level 6	Implementation dependent	Static
dot11 Tx power level 7	Implementation dependent	Static
dot11 Tx power level 8	Implementation dependent	Static
dot11 current Tx Power Level	Implementation dependent	Dynamic
dot11 Reg Domains Supported Table		
dot11 Reg domains supported	Implementation dependent	Static
dot11 Frequency bands supported	Implementation dependent	Static
dot11 PHY Antennas List Table		
dot 11 Supported Tx antenna	Implementation dependent	Static
dot11 Supported Rx antenna	Implementation dependent	Static
dot 11 Diversity selection Rx	Implementation dependent	Dynamic

Table 92—MIB attribute default values/ranges (continued)

Managed object	Default value/range	Operational semantics
dot11 Supported Data Rates Tx Table		
dot11 Supported data rates Tx value	6, 9, 12, 18, 24, 36, 48, and 54 Mbit/s Mandatory rates: 6, 12, and 24	Static
dot11SupportedDataRatesRxTable		
dot11 Supported data rates Rx value	6, 9, 12, 18, 24, 36, 48, and 54 Mbit/s Mandatory rates: 6, 12, and 24	Static
dot11 PHY OFDM Table		
dot11 Current frequency	Implementation dependent	Dynamic
dot11 TI threshold	Implementation dependent	Dynamic

A simplified equation may be used.

$$\text{TXTIME} = T_{\text{PREAMBLE}} + T_{\text{SIGNAL}} + (16 + 8 \times \text{LENGTH} + 6)/\text{DATARATE} + T_{\text{SYM}}/2 \quad (30)$$

Equation (30) does not include the effect of rounding to the next OFDM symbol and may be in error by $\pm 2 \mu\text{s}$.

17.4.4 OFDM PHY characteristics

The static OFDM PHY characteristics, provided through the PLME-CHARACTERISTICS service primitive, are shown in Table 93. The definitions for these characteristics are given in 10.4.

17.5 OFDM PMD sublayer

17.5.1 Scope and field of application

This subclause describes the PMD services provided to the PLCP for the OFDM PHY. Also defined in this subclause are the functional, electrical, and RF characteristics required for interoperability of implementations conforming to this specification. The relationship of this specification to the entire OFDM PHY is shown in Figure 126.

17.5.2 Overview of service

The OFDM PMD sublayer accepts PLCP sublayer service primitives and provides the actual means by which data is transmitted or received from the medium. The combined function of the OFDM PMD sublayer primitives and parameters for the receive function results in a data stream, timing information, and associated received signal parameters being delivered to the PLCP sublayer. A similar functionality shall be provided for data transmission.

Table 93—OFDM PHY characteristics

Characteristics	Value
aSlotTime	9 μ s
aSIFSTime	16 μ s
aCCATime	< 4 μ s
aRxTxTurnaroundTime	< 2 μ s
aTxPLCPDelay	Implementation dependent
aRxPLCPDelay	Implementation dependent
aRxTxSwitchTime	<< 1 μ s
aTxRampOnTime	Implementation dependent
aTxRampOffTime	Implementation dependent
aTxRFDelay	Implementation dependent
aRxRFDelay	Implementation dependent
aAirPropagationTime	<< 1 μ s
aMACProcessingDelay	< 2 μ s
aPreambleLength	20 μ s
aPLCPHeaderLength	4 μ s
aMPDUMaxLength	4095
aCWmin	15
aCWmax	1023

17.5.3 Overview of interactions

The primitives associated with the IEEE 802.11 PLCP sublayer to the OFDM PMD fall into two basic categories

- a) Service primitives that support PLCP peer-to-peer interactions;
- b) Service primitives that have local significance and support sublayer-to-sublayer interactions.

17.5.4 Basic service and options

All of the service primitives described in this subclause are considered mandatory, unless otherwise specified.

17.5.4.1 PMD_SAP peer-to-peer service primitives

Table 94 indicates the primitives for peer-to-peer interactions.

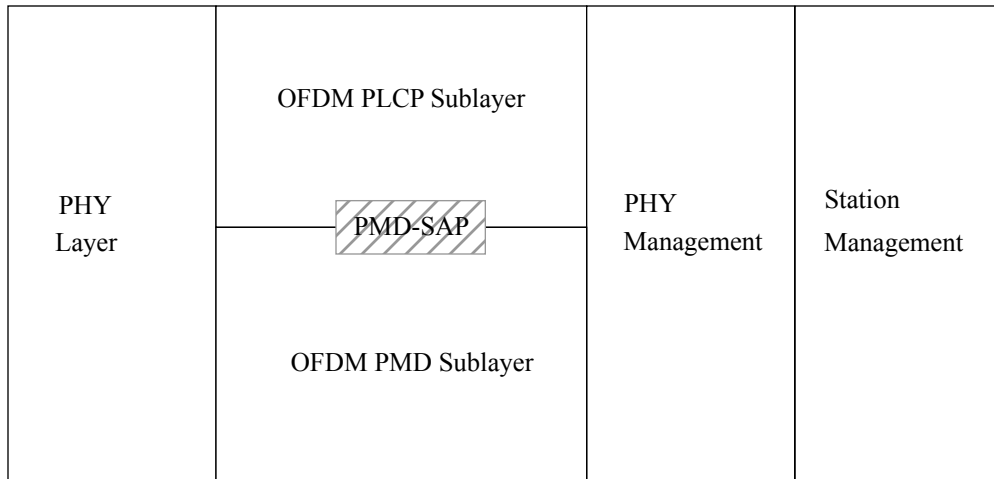

Figure 126—PMD layer reference model

Table 94—PMD_SAP peer-to-peer service primitives

Primitive	Request	Indicate	Confirm	Response
PMD_DATA	X	X	—	—

17.5.4.2 PMD_SAP sublayer-to-sublayer service primitives

Table 95 indicates the primitives for sublayer-to-sublayer interactions.

Table 95—PMD_SAP sublayer-to-sublayer service primitives

Primitive	Request	Indicate	Confirm	Response
PMD_TXSTART	X	—	—	—
PMD_TXEND	X	—	—	—
PMD_TXPWRLVL	X	—	—	—
PMD_RATE	X	—	—	—
PMD_RSSI	—	X	—	—

17.5.4.3 PMD_SAP service primitive parameters

Table 96 shows the parameters used by one or more of the PMD_SAP service primitives.

17.5.5 PMD_SAP detailed service specification

This subclause describes the services provided by each PMD primitive.

Table 96—List of parameters for the PMD primitives

Parameter	Associate primitive	Value
TXD_UNIT	PMD_DATA.request	One(1), Zero(0): one OFDM symbol value
RXD_UNIT	PMD_DATA.indicate	One(1), Zero(0): one OFDM symbol value
TXPWR_LEVEL	PMD_TXPWRLVL.request	1–8 (max of 8 levels)
RATE	PMD_RATE.request	12 Mbit/s (for BPSK) 24 Mbit/s (for QPSK) 48 Mbit/s (for 16-QAM) 72 Mbit/s (for 64-QAM)
RSSI	PMD_RSSI.indicate	0–8 bits of RSSI

17.5.5.1 PMD_DATA.request

17.5.5.1.1 Function

This primitive defines the transfer of data from the PLCP sublayer to the PMD entity.

17.5.5.1.2 Semantic of the service primitive

This primitive shall provide the following parameters:

PMD_DATA.request(TXD_UNIT)

The TXD_UNIT parameter shall be the n-bit combination of “0” and “1” for one symbol of OFDM modulation. If the length of a coded MPDU (C-MPDU) is shorter than n bits, “0” bits are added to form an OFDM symbol. This parameter represents a single block of data which, in turn, shall be used by the PHY to be encoded into an OFDM transmitted symbol.

17.5.5.1.3 When generated

This primitive shall be generated by the PLCP sublayer to request transmission of one OFDM symbol. The data clock for this primitive shall be supplied by the PMD layer based on the OFDM symbol clock.

17.5.5.1.4 Effect of receipt

The PMD performs transmission of the data.

17.5.5.2 PMD_DATA.indicate

17.5.5.2.1 Function

This primitive defines the transfer of data from the PMD entity to the PLCP sublayer.

17.5.5.2.2 Semantic of the service primitive

This primitive shall provide the following parameters:

PMD_DATA.indicate(RXD_UNIT)

The RXD_UNIT parameter shall be “0” or “1,” and shall represent either a signal field bit or a data field bit after the decoding of the convolutional code by the PMD entity.

17.5.5.2.3 When generated

This primitive, generated by the PMD entity, forwards received data to the PLCP sublayer. The data clock for this primitive shall be supplied by the PMD layer based on the OFDM symbol clock.

17.5.5.2.4 Effect of receipt

The PLCP sublayer interprets the bits that are recovered as part of the PLCP convergence procedure, or passes the data to the MAC sublayer as part of the MPDU.

17.5.5.3 PMD_TXSTART.request

17.5.5.3.1 Function

This primitive, generated by the PHY PLCP sublayer, initiates PPDU transmission by the PMD layer.

17.5.5.3.2 Semantic of the service primitive

This primitive shall provide the following parameters:

PMD_TXSTART.request

17.5.5.3.3 When generated

This primitive shall be generated by the PLCP sublayer to initiate the PMD layer transmission of the PPDU. The PHY-TXSTART.request primitive shall be provided to the PLCP sublayer prior to issuing the PMD_TXSTART command.

17.5.5.3.4 Effect of receipt

PMD_TXSTART initiates transmission of a PPDU by the PMD sublayer.

17.5.5.4 PMD_TXEND.request

17.5.5.4.1 Function

This primitive, generated by the PHY PLCP sublayer, ends PPDU transmission by the PMD layer.

17.5.5.4.2 Semantic of the service primitive

This primitive shall provide the following parameters:

PMD_TXEND.request

17.5.5.4.3 When generated

This primitive shall be generated by the PLCP sublayer to terminate the PMD layer transmission of the PPDU.

17.5.5.4.4 Effect of receipt

PMD_TXEND terminates transmission of a PPDU by the PMD sublayer.

17.5.5.5 PMD_TXPWRLVL.request

17.5.5.5.1 Function

This primitive, generated by the PHY PLCP sublayer, selects the power level used by the PHY for transmission.

17.5.5.5.2 Semantic of the service primitive

This primitive shall provide the following parameters:

PMD_TXPWRLVL.request(TXPWR_LEVEL)

TXPWR_LEVEL selects which of the transmit power levels should be used for the current packet transmission. The number of available power levels shall be determined by the MIB parameter aNumberSupportedPowerLevels. Subclause 17.3.9.1 provides further information on the OFDM PHY power level control capabilities.

17.5.5.5.3 When generated

This primitive shall be generated by the PLCP sublayer to select a specific transmit power. This primitive shall be applied prior to setting PMD_TXSTART into the transmit state.

17.5.5.5.4 Effect of receipt

PMD_TXPWRLVL immediately sets the transmit power level to that given by TXPWR_LEVEL.

17.5.5.6 PMD_RATE.request

17.5.5.6.1 Function

This primitive, generated by the PHY PLCP sublayer, selects the modulation rate that shall be used by the OFDM PHY for transmission.

17.5.5.6.2 Semantic of the service primitive

This primitive shall provide the following parameters:

PMD_RATE.request(RATE)

RATE selects which of the OFDM PHY data rates shall be used for MPDU transmission. Subclause 17.3.8.6 provides further information on the OFDM PHY modulation rates. The OFDM PHY rate change capability is described in detail in 17.3.7.

17.5.5.6.3 When generated

This primitive shall be generated by the PLCP sublayer to change or set the current OFDM PHY modulation rate used for the MPDU portion of a PPDU.

17.5.5.6.4 Effect of receipt

The receipt of PMD_RATE selects the rate that shall be used for all subsequent MPDU transmissions. This rate shall be used for transmission only. The OFDM PHY shall still be capable of receiving all the required OFDM PHY modulation rates.

17.5.5.7 PMD_RSSI.indicate

17.5.5.7.1 Function

This primitive, generated by the PMD sublayer, provides the received signal strength to the PLCP and MAC entity.

17.5.5.7.2 Semantic of the service primitive

This primitive shall provide the following parameters:

PMD_RSSI.indicate(RSSI)

The RSSI shall be a measure of the RF energy received by the OFDM PHY. RSSI indications of up to eight bits (256 levels) are supported.

17.5.5.7.3 When generated

This primitive shall be generated by the PMD when the OFDM PHY is in the receive state. It shall be available continuously to the PLCP which, in turn, shall provide the parameter to the MAC entity.

17.5.5.7.4 Effect of receipt

This parameter shall be provided to the PLCP layer for information only. The RSSI may be used as part of a CCA scheme.

Annex A

(normative)

Protocol Implementation Conformance Statement (PICS) proforma

A.4.3 IUT configuration

Add item *CF6 to the following table in this subclause:

Item	IUT configuration	References	Status	Support
* CF1	Access point	5.2	O.1	Yes <input type="checkbox"/> No <input type="checkbox"/>
* CF2	Independent station (not an AP)	5.2	O.1	Yes <input type="checkbox"/> No <input type="checkbox"/>
* CF3	Frequency-hopping spread spectrum (FHSS) PHY for the 2.4 GHz band	—	O.2	Yes <input type="checkbox"/> No <input type="checkbox"/>
* CF4	Direct sequence spread spectrum (DSSS) PHY for the 2.4 GHz band	—	O.2	Yes <input type="checkbox"/> No <input type="checkbox"/>
* CF5	Infrared PHY	—	O.2	Yes <input type="checkbox"/> No <input type="checkbox"/>
* CF6	OFDM PHY for the 5 GHz band	—	O.2	Yes <input type="checkbox"/> No <input type="checkbox"/>

Insert a new subclause A.4.8 for the optional parameters:

A.4.8 Orthogonal frequency division multiplex PHY functions

Item	Feature	References	Status	Support
OF1: OFDM PHY Specific Service Parameters				
OF1.1	TXVECTOR parameter: LENGTH	17.2.2.1	M	Yes <input type="checkbox"/> No <input type="checkbox"/>
OF1.2	TXVECTOR parameter: DATARATE	17.2.2.2	M	Yes <input type="checkbox"/> No <input type="checkbox"/>
OF1.2.1	DATARATE = 6.0 Mbit/s	17.2.2.2	M	Yes <input type="checkbox"/> No <input type="checkbox"/>
*OF1.2.2	DATARATE = 9.0 Mbit/s	17.2.2.2	O	Yes <input type="checkbox"/> No <input type="checkbox"/>
OF1.2.3	DATARATE = 12.0 Mbit/s	17.2.2.2	M	Yes <input type="checkbox"/> No <input type="checkbox"/>
*OF1.2.4	DATARATE = 18.0 Mbit/s	17.2.2.2	O	Yes <input type="checkbox"/> No <input type="checkbox"/>
OF1.2.5	DATARATE = 24.0 Mbit/s	17.2.2.2	M	Yes <input type="checkbox"/> No <input type="checkbox"/>
*OF1.2.6	DATARATE = 36.0 Mbit/s	17.2.2.2	O	Yes <input type="checkbox"/> No <input type="checkbox"/>
*OF1.2.7	DATARATE = 48.0 Mbit/s	17.2.2.2	O	Yes <input type="checkbox"/> No <input type="checkbox"/>
*OF1.2.8	DATARATE = 54.0 Mbit/s	17.2.2.2	O	Yes <input type="checkbox"/> No <input type="checkbox"/>
OF1.3	TXVECTOR parameter: SERVICE	17.2.2.3	M	Yes <input type="checkbox"/> No <input type="checkbox"/>

Item	Feature	References	Status	Support
OF1.4	TXVECTOR parameter: TXPWR_LEVEL	17.2.2.4	M	Yes <input type="checkbox"/> No <input type="checkbox"/>
OF1.5	RXVECTOR parameter: LENGTH	17.2.3.1	M	Yes <input type="checkbox"/> No <input type="checkbox"/>
OF1.6	RXVECTOR parameter: RSSI	17.2.3.2	M	Yes <input type="checkbox"/> No <input type="checkbox"/>
OF2: OFDM PLCP sublayer				
OF2.1	RATE-dependent parameters	17.3.2.2	M	Yes <input type="checkbox"/> No <input type="checkbox"/>
OF2.2	Timing related parameters	17.3.2.3	M	Yes <input type="checkbox"/> No <input type="checkbox"/>
OF2.3	PLCP Preamble: SYNC	17.3.3	M	Yes <input type="checkbox"/> No <input type="checkbox"/>
OF2.4	PLCP header: SIGNAL	17.3.4	M	Yes <input type="checkbox"/> No <input type="checkbox"/>
OF2.5	PLCP header: LENGTH	17.3.4.1	M	Yes <input type="checkbox"/> No <input type="checkbox"/>
OF2.6	PLCP header: RATE	17.3.4.2	M	Yes <input type="checkbox"/> No <input type="checkbox"/>
OF2.7	PLCP header: parity, reserve	17.3.4.3	M	Yes <input type="checkbox"/> No <input type="checkbox"/>
OF2.8	PLCP header: SIGNAL TAIL	17.3.4.3	M	Yes <input type="checkbox"/> No <input type="checkbox"/>
OF2.9	PLCP header: SERVICE	17.3.5.1	M	Yes <input type="checkbox"/> No <input type="checkbox"/>
OF2.10	PPDU: TAIL	17.3.5.2	M	Yes <input type="checkbox"/> No <input type="checkbox"/>
OF2.11	PPDU: PAD	17.3.5.3	M	Yes <input type="checkbox"/> No <input type="checkbox"/>
OF2.12	PLCP/OFDM PHY data scrambler and descrambler	17.3.5.4	M	Yes <input type="checkbox"/> No <input type="checkbox"/>
OF2.13	Convolutional encoder	17.3.5.5	M	Yes <input type="checkbox"/> No <input type="checkbox"/>
OF2.13.1	Rate $R = 1/2$	17.3.5.5	M	Yes <input type="checkbox"/> No <input type="checkbox"/>
OF2.13.2	Punctured coding $R = 2/3$	17.3.5.5	OF1.2.7:M	Yes <input type="checkbox"/> No <input type="checkbox"/> N/A <input type="checkbox"/>
OF2.13.3	Punctured coding $R = 3/4$	17.3.5.5	OF1.2.2 OR OF1.2.4 OR OF1.2.6 OR OF1.2.8:M	Yes <input type="checkbox"/> No <input type="checkbox"/> N/A <input type="checkbox"/>
OF2.14	Data interleaving	17.3.5.6	M	Yes <input type="checkbox"/> No <input type="checkbox"/>
OF2.15	Subcarrier modulation mapping	17.3.5.7	M	Yes <input type="checkbox"/> No <input type="checkbox"/>
OF2.15.1	BPSK	17.3.5.7	M	Yes <input type="checkbox"/> No <input type="checkbox"/>
OF2.15.2	QPSK	17.3.5.7	M	Yes <input type="checkbox"/> No <input type="checkbox"/>
OF2.15.3	16-QAM	17.3.5.7	M	Yes <input type="checkbox"/> No <input type="checkbox"/>
OF2.15.4	64-QAM	17.3.5.7	OF1.2.7 OR OF1.2.8:M	Yes <input type="checkbox"/> No <input type="checkbox"/> N/A <input type="checkbox"/>
OF2.16	Pilot subcarriers	17.3.5.8	M	Yes <input type="checkbox"/> No <input type="checkbox"/>
OF2.17	OFDM modulation	17.3.5.9	M	Yes <input type="checkbox"/> No <input type="checkbox"/>
OF2.18	Packet duration calculation	17.3.5.10	M	Yes <input type="checkbox"/> No <input type="checkbox"/>

Item	Feature	References	Status	Support
OF2.19	CCA			
OF2.19.1	CCA: RSSI	17.3.6	M	Yes <input type="checkbox"/> No <input type="checkbox"/>
OF2.19.2	CCA: indication to MAC sublayer	17.3.6	M	Yes <input type="checkbox"/> No <input type="checkbox"/>
OF2.20	PLCP data modulation and modulation rate change	17.3.7	M	Yes <input type="checkbox"/> No <input type="checkbox"/>
OF3: PDM Operating Specification General				
OF3.1	Occupied channel bandwidth	17.3.8.1	M	Yes <input type="checkbox"/> No <input type="checkbox"/>
OF3.2	Operating frequency range	17.3.8.2	M	Yes <input type="checkbox"/> No <input type="checkbox"/>
OF3.3	Channelization	17.3.8.3	M	Yes <input type="checkbox"/> No <input type="checkbox"/>
*OF3.3.1	Lower U-NII subband (5.15–5.25 GHz)	17.3.8.3	O.1	Yes <input type="checkbox"/> No <input type="checkbox"/>
*OF3.3.2	Middle U-NII subband (5.25–5.35 GHz)	17.3.8.3	O.1	Yes <input type="checkbox"/> No <input type="checkbox"/>
*OF3.3.3	Upper U-NII subband (5.725–5.825 GHz)	17.3.8.3	O.1	Yes <input type="checkbox"/> No <input type="checkbox"/>
OF3.4	Number of operating channels	17.3.8.3	M	Yes <input type="checkbox"/> No <input type="checkbox"/>
OF3.5	Operating channel frequencies	17.3.8.3	M	Yes <input type="checkbox"/> No <input type="checkbox"/>
OF3.6	Transmit and receive in band and out of band spurious emission	17.3.8.4	M	Yes <input type="checkbox"/> No <input type="checkbox"/>
OF3.7	TX RF delay	17.3.8.5	M	Yes <input type="checkbox"/> No <input type="checkbox"/>
OF3.8	Slot Time	17.3.8.6	M	Yes <input type="checkbox"/> No <input type="checkbox"/>
OF3.9	Transmit and receive antenna port impedance	17.3.8.7	M	Yes <input type="checkbox"/> No <input type="checkbox"/>
OF3.10	Transmit and receive operating temperature range	17.3.8.8	M	Yes <input type="checkbox"/> No <input type="checkbox"/>
OF3.10.1	Type 1 (0 °C to 40 °C)	17.3.8.8	M	Yes <input type="checkbox"/> No <input type="checkbox"/>
OF3.10.2	Type 2 (–20 °C to 50 °C)	17.3.8.8	O	Yes <input type="checkbox"/> No <input type="checkbox"/>
OF3.10.3	Type 3 (–30 °C to 70 °C)	17.3.8.8	O	Yes <input type="checkbox"/> No <input type="checkbox"/>
OF4: PMD Transmit Specification				
OF4.1	Transmit power levels		M	Yes <input type="checkbox"/> No <input type="checkbox"/>
OF4.1.1	Power level (5.15–5.25 GHz)	17.3.9.1	OF3.3.1:M	Yes <input type="checkbox"/> No <input type="checkbox"/> N/A <input type="checkbox"/>
OF4.1.2	Power level (5.25–5.35 GHz)	17.3.9.1	OF3.3.2:M	Yes <input type="checkbox"/> No <input type="checkbox"/> N/A <input type="checkbox"/>
OF4.1.3	Power level (5.725–5.825 GHz)	17.3.9.1	OF3.3.3:M	Yes <input type="checkbox"/> No <input type="checkbox"/> N/A <input type="checkbox"/>
OF4.2	Spectrum mask	17.3.9.2	M	Yes <input type="checkbox"/> No <input type="checkbox"/>
OF4.3	Spurious	17.3.9.3	M	Yes <input type="checkbox"/> No <input type="checkbox"/>
OF4.4	Center frequency tolerance	17.3.9.4	M	Yes <input type="checkbox"/> No <input type="checkbox"/>
OF4.5	Clock frequency tolerance	17.3.9.5	M	Yes <input type="checkbox"/> No <input type="checkbox"/>
OF4.6	Modulation accuracy			Yes <input type="checkbox"/> No <input type="checkbox"/>
OF4.6.1	Center frequency leakage	17.3.9.6.1	M	Yes <input type="checkbox"/> No <input type="checkbox"/>

Item	Feature	References	Status	Support
OF4.6.2	Spectral flatness	17.3.9.6.2	M	Yes <input type="checkbox"/> No <input type="checkbox"/>
OF4.6.3	Transmitter constellation error < -5 dB	17.3.9.6.3	M	Yes <input type="checkbox"/> No <input type="checkbox"/>
OF4.6.4	Transmitter constellation error < -8 dB	17.3.9.6.3	OF1.2.2:M	Yes <input type="checkbox"/> No <input type="checkbox"/> N/A <input type="checkbox"/>
OF4.6.5	Transmitter constellation error < -10 dB	17.3.9.6.3	M	Yes <input type="checkbox"/> No <input type="checkbox"/>
OF4.6.6	Transmitter constellation error < -13 dB	17.3.9.6.3	OF1.2.4:M	Yes <input type="checkbox"/> No <input type="checkbox"/> N/A <input type="checkbox"/>
OF4.6.7	Transmitter constellation error < -16 dB	17.3.9.6.3	M	Yes <input type="checkbox"/> No <input type="checkbox"/>
OF4.6.8	Transmitter constellation error < -19 dB	17.3.9.6.3	OF1.2.6:M	Yes <input type="checkbox"/> No <input type="checkbox"/> N/A <input type="checkbox"/>
OF4.6.9	Transmitter constellation error < -22 dB	17.3.9.6.3	OF1.2.7:M	Yes <input type="checkbox"/> No <input type="checkbox"/> N/A <input type="checkbox"/>
OF4.6.10	Transmitter constellation error < -25 dB	17.3.9.6.3	OF1.2.8:M	Yes <input type="checkbox"/> No <input type="checkbox"/> N/A <input type="checkbox"/>
OF5: PMD Receiver Specifications				
OF5.1	Minimum input level sensitivity at PER = 10% with 1000 octet frames			
OF5.1.1	-82 dBm for 6 Mbit/s	17.3.10.1	M	Yes <input type="checkbox"/> No <input type="checkbox"/>
OF5.1.2	-81 dBm for 9 Mbit/s	17.3.10.1	OF1.2.2:M	Yes <input type="checkbox"/> No <input type="checkbox"/> N/A <input type="checkbox"/>
OF5.1.3	-79 dBm for 12 Mbit/s	17.3.10.1	M	Yes <input type="checkbox"/> No <input type="checkbox"/>
OF5.1.4	-77 dBm for 18 Mbit/s	17.3.10.1	OF1.2.4:M	Yes <input type="checkbox"/> No <input type="checkbox"/> N/A <input type="checkbox"/>
OF5.1.5	-74 dBm for 24 Mbit/s	17.3.10.1	M	Yes <input type="checkbox"/> No <input type="checkbox"/>
OF5.1.6	-70 dBm for 36 Mbit/s	17.3.10.1	OF1.2.6:M	Yes <input type="checkbox"/> No <input type="checkbox"/> N/A <input type="checkbox"/>
OF5.1.7	-66 dBm for 48 Mbit/s	17.3.10.1	OF1.2.7:M	Yes <input type="checkbox"/> No <input type="checkbox"/> N/A <input type="checkbox"/>
OF5.1.8	-65 dBm for 54 Mbit/s	17.3.10.1	OF1.2.8:M	Yes <input type="checkbox"/> No <input type="checkbox"/> N/A <input type="checkbox"/>
OF5.2	Adjacent channel rejection	17.3.10.2	M	Yes <input type="checkbox"/> No <input type="checkbox"/>
OF5.3	Non-adjacent channel rejection	17.3.10.3	M	Yes <input type="checkbox"/> No <input type="checkbox"/>
OF5.4	Maximum input level	17.3.10.4	M	Yes <input type="checkbox"/> No <input type="checkbox"/>
OF5.5	CCA sensitivity	17.3.10.5	M	Yes <input type="checkbox"/> No <input type="checkbox"/>
OF6: PLCP Transmit Procedure				
OF6.1	Transmit: transmit on MAC request	17.3.13	M	Yes <input type="checkbox"/> No <input type="checkbox"/>
OF6.2.	Transmit: format and data encoding	17.3.13	M	Yes <input type="checkbox"/> No <input type="checkbox"/>
OF6.3	Transmit: timing	17.3.13	M	Yes <input type="checkbox"/> No <input type="checkbox"/>
OF7: PLCP Receive Procedure				
OF7.1	Receive: receive and data decoding	17.3.14	M	Yes <input type="checkbox"/> No <input type="checkbox"/>
OF8: PHY LME				
OF8.1	PLME: support PLME_SAP management primitives	17.4.1	M	Yes <input type="checkbox"/> No <input type="checkbox"/>
OF8.2	PLME: support PHY management information base	17.4.2	M	Yes <input type="checkbox"/> No <input type="checkbox"/>

Item	Feature	References	Status	Support
OF8.3	PLME: support PHY characteristics	17.4.3	M	Yes <input type="checkbox"/> No <input type="checkbox"/>
OF9: OFDM PMD Sublayer				
OF9.1	PMD: support PMD_SAP peer-to-peer service primitives	17.5.4.1, 17.5.5.1, 17.5.5.2	M	Yes <input type="checkbox"/> No <input type="checkbox"/>
OF9.2	PMD: support PMD_SAP sublayer-to-sublayer service primitives	17.5.4.2, 17.5.5.3, 17.5.5.4, 17.5.5.5, 17.5.5.6, 17.5.5.7	M	Yes <input type="checkbox"/> No <input type="checkbox"/>
OF9.3	PMD_SAP service primitive parameters			
OF9.3.1	Parameter: TXD_UNIT	17.5.4.3	M	Yes <input type="checkbox"/> No <input type="checkbox"/>
OF9.3.2	Parameter: RXD_UNIT	17.5.4.3	M	Yes <input type="checkbox"/> No <input type="checkbox"/>
OF9.3.3	Parameter: TXPWR_LEVEL	17.5.4.3	M	Yes <input type="checkbox"/> No <input type="checkbox"/>
OF9.3.4	Parameter: RATE (12 Mbit/s)	17.5.4.3	M	Yes <input type="checkbox"/> No <input type="checkbox"/>
OF9.3.5	Parameter: RATE (24 Mbit/s)	17.5.4.3	M	Yes <input type="checkbox"/> No <input type="checkbox"/>
OF9.3.6	Parameter: RATE (48 Mbit/s)	17.5.4.3	M	Yes <input type="checkbox"/> No <input type="checkbox"/>
OF9.3.7	Parameter: RATE (72 Mbit/s)	17.5.4.3	O	Yes <input type="checkbox"/> No <input type="checkbox"/>
OF9.3.8	Parameter: RSSI	17.5.4.3	M	Yes <input type="checkbox"/> No <input type="checkbox"/>
OF10: Geographic Area Specific Requirements				
*OF10.1	Geographic areas	17.3.8.2, 17.3.8.3, 17.3.8.4, 17.3.9.3	M	Yes <input type="checkbox"/> No <input type="checkbox"/>

Annex D

(normative)

ASN.1 encoding of the MAC and PHY MIB

Add the following variables to the PHY MIB:

1. In “Major sections” of Annex D, add the following text to the end of “PHY Attributes” section:
-- dot11PhyOFDMTable ::= {dot11phy 11}”

2. In “dot11PhyOperation TABLE” section of Annex D, update “dot11PHYType attribute” section as the following text:
“dot11PHYType OBJECT-TYPE
SYNTAX INTEGER {fhss(1), dsss(2), irbaseband(3), ofdm(4)}
MAX-ACCESS read-only
STATUS current
DESCRIPTION”

“This is an 8-bit integer value that identifies the PHY type supported by the attached PLCP and PMD. Currently defined values and their corresponding PHY types are:

FHSS 2.4 GHz = 01, DSSS 2.4 GHz = 02, IR Baseband = 03,
OFDM 5 GHz = 04”

::= {dot11PhyOperationEntry 1}

3. In Annex D, add the following text to the end of “dot11SupportedDataRateRx TABLE” section:

--*****
-- * dot11PhyOFDM TABLE
--*****

dot11PhyOFDMTable OBJECT-TYPE
SYNTAX SEQUENCE OF Dot11PhyOFDMEntry
MAX-ACCESS not-accessible
STATUS current
DESCRIPTION

“Group of attributes for dot11PhyOFDMTable. Implemented as a table indexed on ifindex to allow for multiple instances on an Agent.”

::= {dot11phy 11}

dot11PhyOFDMEntry OBJECT-TYPE
SYNTAX Dot11PhyOFDMEntry
MAX-ACCESS not-accessible
STATUS current
DESCRIPTION

“An entry in the dot11PhyOFDM Table.

ifIndex - Each IEEE 802.11 interface is represented by an ifEntry. Interface tables in this MIB module are indexed by ifIndex.”

INDEX {ifIndex}

::= {dot11PhyOFDMTable 1}

Dot11PhyOFDMEntry ::= SEQUENCE {
dot11CurrentFrequency INTEGER,
dot11TThreshold INTEGER,
dot11FrequencyBandsSupported}

dot11CurrentFrequency OBJECT-TYPE

SYNTAX INTEGER (0..99)

MAX-ACCESS read-write

STATUS current

DESCRIPTION

“The number of the current operating frequency channel of the OFDM PHY.”

::= {dot11PhyOFDMEntry 1}

dot11TIThreshold

SYNTAX INTEGER32

MAX-ACCESS read-write

STATUS current

DESCRIPTION

“The Threshold being used to detect a busy medium (frequency).

CCA shall report a busy medium upon detecting the RSSI above this threshold.”

::= {dot11PhyOFDMEntry 2}

dot11FrequencyBandsSupported

SYNTAX INTEGER (1..7)

MAX-ACCESS read-only

STATUS current

DESCRIPTION

“The capability of the OFDM PHY implementation to operate in the three U-NII bands. Coded as an integer value of a three bit field as follows:

bit 0 .. capable of operating in the lower (5.15-5.25 GHz) U-NII band

bit 1 .. capable of operating in the middle (5.25-5.35 GHz) U-NII band

bit 2 .. capable of operating in the upper (5.725-5.825 GHz) U-NII band

For example, for an implementation capable of operating in the lower and mid bands this attribute would take the value 3.”

::= {dot11PhyOFDMEntry 3}

--*****

-- * End of dot11PhyOFDM TABLE

--

4. In Annex D, update “compliance statements” section as the following text:

-- * compliance statements

--

dot11Compliance MODULE-COMPLIANCE

STATUS current

DESCRIPTION

“The compliance statement for SNMPv2 entities that implement the IEEE 802.11 MIB.”

MODULE -- this module

MANDATORY-GROUPS {

dot11SMTbase,

dot11MACbase, dot11CountersGroup,

dot11SmtAuthenticationAlgorithms,

dot11ResourceTypeID, dot11PhyOperationComplianceGroup}

GROUP dot11PhyDSSSComplianceGroup

DESCRIPTION

“Implementation of this group is required when object

dot11PHYType has the value of dsss. This group is

mutually exclusive with the groups dot11PhyIRComplianceGroup,

dot11PhyFHSSComplianceGroup and dot11PhyOFDMComplianceGroup.”

GROUP dot11PhyIRComplianceGroup

DESCRIPTION

“Implementation of this group is required when object

dot11PHYType has the value of irbaseband. This group is mutually exclusive with the groups dot11PhyDSSSComplianceGroup, dot11PhyFHSSComplianceGroup and dot11PhyOFDMComplianceGroup.”

GROUP dot11PhyFHSSComplianceGroup
DESCRIPTION

“Implementation of this group is required when object dot11PHYType has the value of fhss. This group is mutually exclusive with the groups dot11PhyDSSSComplianceGroup, dot11PhyIRComplianceGroup and dot11PhyOFDMComplianceGroup.”

GROUP dot11OFDMComplianceGroup
DESCRIPTION

“Implementation of this group is required when object dot11PHYType has the value of ofdm. This group is mutually exclusive with the groups dot11PhyDSSSComplianceGroup, dot11PhyIRComplianceGroup and dot11PhyFHSSComplianceGroup.”

-- OPTIONAL-GROUPS {dot11SMTprivacy, dot11MACStatistics,
-- dot11PhyAntennaComplianceGroup, dot11PhyTxPowerComplianceGroup,
-- dot11PhyRegDomainsSupportGroup,
-- dot11PhyAntennasListGroup, dot11PhyRateGroup}
==

::= {dot11Compliances 1}

5. In “Groups - units of conformance” section of Annex D, add the following text to the end of “dot11CountersGroup” section:

dot11PhyOFDMComplianceGroup OBJECT-GROUP
OBJECTS {
 dot11CurrentFrequency,
 dot11TITThreshold,
 dot11FrequencyBandsSupported}
STATUS current
DESCRIPTION
“Attributes that configure the OFDM for IEEE 802.11.”
::= {dot11Groups 17}”

Annex G

(informative)

Add Annex G (a new annex):

An example of encoding a frame for OFDM PHY

G.1 Introduction

The purpose of this annex is to show an example of encoding a frame for the OFDM PHY, as described in Clause 17 of IEEE Std 802.11, 1999 Edition. This example covers all the encoding details defined by the base standard.

The encoding illustration goes through the following stages:

- a) Generating the short training sequence section of the preamble;
- b) Generating the long preamble sequence section of the preamble;
- c) Generating the SIGNAL field bits;
- d) Coding and interleaving the SIGNAL field bits;
- e) Mapping the SIGNAL field into frequency domain;
- f) Pilot insertion;
- g) Transforming into time domain;
- h) Delineating the data octet stream into a bit stream;
- i) Prepending the SERVICE field and adding the pad bits, thus forming the DATA;
- j) Scrambling and zeroing the tail bits;
- k) Encoding the DATA with a convolutional encoder and puncturing;
- l) Mapping into complex 16-QAM symbols;
- m) Pilot insertion;
- n) Transforming from frequency to time and adding a circular prefix;
- o) Concatenating the OFDM symbols into a single, time-domain signal.

In the description of time domain waveforms, a complex baseband signal at 20 Msamples/s shall be used.

This example uses the 36 Mbit/s data rate and a message of 100 octets. These parameters are chosen in order to illustrate as many nontrivial aspects of the processing as possible.

- a) Use of several bits per symbol (4 in our case);
- b) Puncturing of the convolutional code;
- c) Interleaving, which uses the LSB–MSB swapping stage;
- d) Scrambling of the pilot subcarriers.

G.2 The message

The message being encoded consists of the first 72 characters of the well-known “Ode to Joy” by F. Schiller:

Joy, bright spark of divinity,
Daughter of Elysium,
Fire-insired we tread
Thy sanctuary.
Thy magic power re-unites
All that custom has divided,
All men become brothers
Under the sway of thy gentle wings...

The message is converted to ASCII; then it is prepended with an appropriate MAC header and a CRC32 is added. The resulting 100 octets PSDU is shown in Table G.1.

Table G.1 – The message

##	Val	Val	Val	Val	Val
1...5	04	02	00	2e	00
6...10	60	08	cd	37	a6
11...15	00	20	d6	01	3c
16...20	f1	00	60	08	ad
21...25	3b	af	00	00	4a
26...30	6f	79	2c	20	62
31...35	72	69	67	68	74
36...45	20	73	70	61	72
41...45	6b	20	6f	66	20
46...50	64	69	76	69	6e
51...55	69	74	79	2c	0a
56...60	44	61	75	67	68
61...65	74	65	72	20	6f
66...70	66	20	45	6c	79
71...75	73	69	75	6d	2c
76...80	0a	46	69	72	65
81...85	2d	69	6e	73	69
86...90	72	65	64	20	77
91...95	65	20	74	72	65
96...100	61	da	57	99	ed

G.3 Generation of the preamble

G.3.1 Generation of the short sequences

The short sequences section of the preamble is described by its frequency domain representation, given in Table G.2.

Table G.2—Frequency domain representation of the short sequences

##	Re	Im	##	Re	Im	##	Re	Im	##	Re	Im
-32	0.0	0.0	-16	1.472	1.472	0	0.0	0.0	16	1.472	1.472
-31	0.0	0.0	-15	0.0	0.0	1	0.0	0.0	17	0.0	0.0
-30	0.0	0.0	-14	0.0	0.0	2	0.0	0.0	18	0.0	0.0
-29	0.0	0.0	-13	0.0	0.0	3	0.0	0.0	19	0.0	0.0
-28	0.0	0.0	-12	-1.472	-1.472	4	-1.472	-1.472	20	1.472	1.472
-27	0.0	0.0	-11	0.0	0.0	5	0.0	0.0	21	0.0	0.0
-26	0.0	0.0	-10	0.0	0.0	6	0.0	0.0	22	0.0	0.0
-25	0.0	0.0	-9	0.0	0.0	7	0.0	0.0	23	0.0	0.0
-24	1.472	1.472	-8	-1.472	-1.472	8	-1.472	-1.472	24	1.472	1.472
-23	0.0	0.0	-7	0.0	0.0	9	0.0	0.0	25	0.0	0.0
-22	0.0	0.0	-6	0.0	0.0	10	0.0	0.0	26	0.0	0.0
-21	0.0	0.0	-5	0.0	0.0	11	0.0	0.0	27	0.0	0.0
-20	-1.472	-1.472	-4	1.472	1.472	12	1.472	1.472	28	0.0	0.0
-19	0.0	0.0	-3	0.0	0.0	13	0.0	0.0	29	0.0	0.0
-18	0.0	0.0	-2	0.0	0.0	14	0.0	0.0	30	0.0	0.0
-17	0.0	0.0	-1	0.0	0.0	15	0.0	0.0	31	0.0	0.0

One period of the IFFT on the contents of Table G.2 is given in Table G.3.

Table G.3—One period of IFFT of the short sequences

##	Re	Im	##	Re	Im	##	Re	Im	##	Re	Im
0	0.046	0.046	1	-0.132	0.002	2	-0.013	-0.079	3	0.143	-0.013
4	0.092	0.000	5	0.143	-0.013	6	-0.013	-0.079	7	-0.132	0.002
8	0.046	0.046	9	0.002	-0.132	10	-0.079	-0.013	11	-0.013	0.143
12	0.000	0.092	13	-0.013	0.143	14	-0.079	-0.013	15	0.002	-0.132
16	0.046	0.046	17	-0.132	0.002	18	-0.013	-0.079	19	0.143	-0.013
20	0.092	0.000	21	0.143	-0.013	22	-0.013	-0.079	23	-0.132	0.002
24	0.046	0.046	25	0.002	-0.132	26	-0.079	-0.013	27	-0.013	0.143
28	0.000	0.092	29	-0.013	0.143	30	-0.079	-0.013	31	0.002	-0.132
32	0.046	0.046	33	-0.132	0.002	34	-0.013	-0.079	35	0.143	-0.013
36	0.092	0.000	37	0.143	-0.013	38	-0.013	-0.079	39	-0.132	0.002
40	0.046	0.046	41	0.002	-0.132	42	-0.079	-0.013	43	-0.013	0.143
44	0.000	0.092	45	-0.013	0.143	46	-0.079	-0.013	47	0.002	-0.132
48	0.046	0.046	49	-0.132	0.002	50	-0.013	-0.079	51	0.143	-0.013
52	0.092	0.000	53	0.143	-0.013	54	-0.013	-0.079	55	-0.132	0.002
56	0.046	0.046	57	0.002	-0.132	58	-0.079	-0.013	59	-0.013	0.143
60	0.000	0.092	61	-0.013	0.143	62	-0.079	-0.013	63	0.002	-0.132

The single period of the short training sequence is extended periodically for 161 samples (about 8 ms), and then multiplied by the window function:

$$W(k) = \begin{cases} 0.5 & k = 0 \\ 1 & 1 \leq k \leq 16 \\ 0.5 & k = 60 \end{cases}$$

The last sample serves as an overlap with the following OFDM symbol. The 161 samples vector is shown in Table G.4. The time-windowing feature illustrated here is not part of the normative specifications.

Table G.4—Time domain representation of the short sequence

##	Re	Im	##	Re	Im	##	Re	Im	##	Re	Im
0	0.023	0.023	1	-0.132	0.002	2	-0.013	-0.079	3	0.143	-0.013
4	0.092	0.000	5	0.143	-0.013	6	-0.013	-0.079	7	-0.132	0.002
8	0.046	0.046	9	0.002	-0.132	10	-0.079	-0.013	11	-0.013	0.143
12	0.000	0.092	13	-0.013	0.143	14	-0.079	-0.013	15	0.002	-0.132
16	0.046	0.046	17	-0.132	0.002	18	-0.013	-0.079	19	0.143	-0.013
20	0.092	0.000	21	0.143	-0.013	22	-0.013	-0.079	23	-0.132	0.002
24	0.046	0.046	25	0.002	-0.132	26	-0.079	-0.013	27	-0.013	0.143
28	0.000	0.092	29	-0.013	0.143	30	-0.079	-0.013	31	0.002	-0.132
32	0.046	0.046	33	-0.132	0.002	34	-0.013	-0.079	35	0.143	-0.013
36	0.092	0.000	37	0.143	-0.013	38	-0.013	-0.079	39	-0.132	0.002
40	0.046	0.046	41	0.002	-0.132	42	-0.079	-0.013	43	-0.013	0.143
44	0.000	0.092	45	-0.013	0.143	46	-0.079	-0.013	47	0.002	-0.132
48	0.046	0.046	49	-0.132	0.002	50	-0.013	-0.079	51	0.143	-0.013
52	0.092	0.000	53	0.143	-0.013	54	-0.013	-0.079	55	-0.132	0.002
56	0.046	0.046	57	0.002	-0.132	58	-0.079	-0.013	59	-0.013	0.143
60	0.000	0.092	61	-0.013	0.143	62	-0.079	-0.013	63	0.002	-0.132
64	0.046	0.046	65	-0.132	0.002	66	-0.013	-0.079	67	0.143	-0.013
68	0.092	0.000	69	0.143	-0.013	70	-0.013	-0.079	71	-0.132	0.002
72	0.046	0.046	73	0.002	-0.132	74	-0.079	-0.013	75	-0.013	0.143
76	0.000	0.092	77	-0.013	0.143	78	-0.079	-0.013	79	0.002	-0.132
80	0.046	0.046	81	-0.132	0.002	82	-0.013	-0.079	83	0.143	-0.013
84	0.092	0.000	85	0.143	-0.013	86	-0.013	-0.079	87	-0.132	0.002
88	0.046	0.046	89	0.002	-0.132	90	-0.079	-0.013	91	-0.013	0.143
92	0.000	0.092	93	-0.013	0.143	94	-0.079	-0.013	95	0.002	-0.132
96	0.046	0.046	97	-0.132	0.002	98	-0.013	-0.079	99	0.143	-0.013
100	0.092	0.000	101	0.143	-0.013	102	-0.013	-0.079	103	-0.132	0.002
104	0.046	0.046	105	0.002	-0.132	106	-0.079	-0.013	107	-0.013	0.143
108	0.000	0.092	109	-0.013	0.143	110	-0.079	-0.013	111	0.002	-0.132
112	0.046	0.046	113	-0.132	0.002	114	-0.013	-0.079	115	0.143	-0.013
116	0.092	0.000	117	0.143	-0.013	118	-0.013	-0.079	119	-0.132	0.002
120	0.046	0.046	121	0.002	-0.132	122	-0.079	-0.013	123	-0.013	0.143

Table G.4—Time domain representation of the short sequence (continued)

##	Re	Im	##	Re	Im	##	Re	Im	##	Re	Im
124	0.000	0.092	125	-0.013	0.143	126	-0.079	-0.013	127	0.002	-0.132
128	0.046	0.046	129	-0.132	0.002	130	-0.013	-0.079	131	0.143	-0.013
132	0.092	0.000	133	0.143	-0.013	134	-0.013	-0.079	135	-0.132	0.002
136	0.046	0.046	137	0.002	-0.132	138	-0.079	-0.013	139	-0.013	0.143
140	0.000	0.092	141	-0.013	0.143	142	-0.079	-0.013	143	0.002	-0.132
144	0.046	0.046	145	-0.132	0.002	146	-0.013	-0.079	147	0.143	-0.013
148	0.092	0.000	149	0.143	-0.013	150	-0.013	-0.079	151	-0.132	0.002
152	0.046	0.046	153	0.002	-0.132	154	-0.079	-0.013	155	-0.013	0.143
156	0.000	0.092	157	-0.013	0.143	158	-0.079	-0.013	159	0.002	-0.132
160	0.023	0.023									

G.3.2 Generation of the long sequences

The frequency domain representation of the long training sequence part of the preamble is given in Table G.5.

Table G.5—Frequency domain representation of the long sequences

##	Re	Im	##	Re	Im	##	Re	Im	##	Re	Im
-32	0.000	0.000	-16	1.000	0.000	0	0.000	0.000	16	1.000	0.000
-31	0.000	0.000	-15	1.000	0.000	1	1.000	0.000	17	-1.000	0.000
-30	0.000	0.000	-14	1.000	0.000	2	-1.000	0.000	18	-1.000	0.000
-29	0.000	0.000	-13	1.000	0.000	3	-1.000	0.000	19	1.000	0.000
-28	0.000	0.000	-12	1.000	0.000	4	1.000	0.000	20	-1.000	0.000
-27	0.000	0.000	-11	-1.000	0.000	5	1.000	0.000	21	1.000	0.000
-26	1.000	0.000	-10	-1.000	0.000	6	-1.000	0.000	22	-1.000	0.000
-25	1.000	0.000	-9	1.000	0.000	7	1.000	0.000	23	1.000	0.000
-24	-1.000	0.000	-8	1.000	0.000	8	-1.000	0.000	24	1.000	0.000
-23	-1.000	0.000	-7	-1.000	0.000	9	1.000	0.000	25	1.000	0.000
-22	1.000	0.000	-6	1.000	0.000	10	-1.000	0.000	26	1.000	0.000
-21	1.000	0.000	-5	-1.000	0.000	11	-1.000	0.000	27	0.000	0.000
-20	-1.000	0.000	-4	1.000	0.000	12	-1.000	0.000	28	0.000	0.000
-19	1.000	0.000	-3	1.000	0.000	13	-1.000	0.000	29	0.000	0.000
-18	-1.000	0.000	-2	1.000	0.000	14	-1.000	0.000	30	0.000	0.000
-17	1.000	0.000	-1	1.000	0.000	15	1.000	0.000	31	0.000	0.000

The time domain representation is derived by performing IFFT on the contents of Table G.5, cyclically extending the result to get the cyclic prefix, and then multiplying with the window function given in G.3.1. The resulting 161 points vector is shown in Table G.6. The samples are appended to the short sequence section by overlapping and adding element 160 of Table G.4 to element 0 of Table G.6.

Table G.6—Time domain representation of the long sequence

##	Re	Im	##	Re	Im	##	Re	Im	##	Re	Im
0	-0.078	0.000	1	0.012	-0.098	2	0.092	-0.106	3	-0.092	-0.115
4	-0.003	-0.054	5	0.075	0.074	6	-0.127	0.021	7	-0.122	0.017
8	-0.035	0.151	9	-0.056	0.022	10	-0.060	-0.081	11	0.070	-0.014
12	0.082	-0.092	13	-0.131	-0.065	14	-0.057	-0.039	15	0.037	-0.098
16	0.062	0.062	17	0.119	0.004	18	-0.022	-0.161	19	0.059	0.015
20	0.024	0.059	21	-0.137	0.047	22	0.001	0.115	23	0.053	-0.004
24	0.098	0.026	25	-0.038	0.106	26	-0.115	0.055	27	0.060	0.088
28	0.021	-0.028	29	0.097	-0.083	30	0.040	0.111	31	-0.005	0.120
32	0.156	0.000	33	-0.005	-0.120	34	0.040	-0.111	35	0.097	0.083
36	0.021	0.028	37	0.060	-0.088	38	-0.115	-0.055	39	-0.038	-0.106
40	0.098	-0.026	41	0.053	0.004	42	0.001	-0.115	43	-0.137	-0.047
44	0.024	-0.059	45	0.059	-0.015	46	-0.022	0.161	47	0.119	-0.004
48	0.062	-0.062	49	0.037	0.098	50	-0.057	0.039	51	-0.131	0.065
52	0.082	0.092	53	0.070	0.014	54	-0.060	0.081	55	-0.056	-0.022
56	-0.035	-0.151	57	-0.122	-0.017	58	-0.127	-0.021	59	0.075	-0.074
60	-0.003	0.054	61	-0.092	0.115	62	0.092	0.106	63	0.012	0.098
64	-0.156	0.000	65	0.012	-0.098	66	0.092	-0.106	67	-0.092	-0.115
68	-0.003	-0.054	69	0.075	0.074	70	-0.127	0.021	71	-0.122	0.017
72	-0.035	0.151	73	-0.056	0.022	74	-0.060	-0.081	75	0.070	-0.014
76	0.082	-0.092	77	-0.131	-0.065	78	-0.057	-0.039	79	0.037	-0.098
80	0.062	0.062	81	0.119	0.004	82	-0.022	-0.161	83	0.059	0.015
84	0.024	0.059	85	-0.137	0.047	86	0.001	0.115	87	0.053	-0.004
88	0.098	0.026	89	-0.038	0.106	90	-0.115	0.055	91	0.060	0.088
92	0.021	-0.028	93	0.097	-0.083	94	0.040	0.111	95	-0.005	0.120
96	0.156	0.000	97	-0.005	-0.120	98	0.040	-0.111	99	0.097	0.083
100	0.021	0.028	101	0.060	-0.088	102	-0.115	-0.055	103	-0.038	-0.106
104	0.098	-0.026	105	0.053	0.004	106	0.001	-0.115	107	-0.137	-0.047
108	0.024	-0.059	109	0.059	-0.015	110	-0.022	0.161	111	0.119	-0.004
112	0.062	-0.062	113	0.037	0.098	114	-0.057	0.039	115	-0.131	0.065

Table G.6—Time domain representation of the long sequence (continued)

##	Re	Im	##	Re	Im	##	Re	Im	##	Re	Im
116	0.082	0.092	117	0.070	0.014	118	-0.060	0.081	119	-0.056	-0.022
120	-0.035	-0.151	121	-0.122	-0.017	122	-0.127	-0.021	123	0.075	-0.074
124	-0.003	0.054	125	-0.092	0.115	126	0.092	0.106	127	0.012	0.098
128	-0.156	0.000	129	0.012	-0.098	130	0.092	-0.106	131	-0.092	-0.115
132	-0.003	-0.054	133	0.075	0.074	134	-0.127	0.021	135	-0.122	0.017
136	-0.035	0.151	137	-0.056	0.022	138	-0.060	-0.081	139	0.070	-0.014
140	0.082	-0.092	141	-0.131	-0.065	142	-0.057	-0.039	143	0.037	-0.098
144	0.062	0.062	145	0.119	0.004	146	-0.022	-0.161	147	0.059	0.015
148	0.024	0.059	149	-0.137	0.047	150	0.001	0.115	151	0.053	-0.004
152	0.098	0.026	153	-0.038	0.106	154	-0.115	0.055	155	0.060	0.088
156	0.021	-0.028	157	0.097	-0.083	158	0.040	0.111	159	-0.005	0.120
160	0.078	0									

G.4 Generation of the SIGNAL field

G.4.1 SIGNAL field bit assignment

The SIGNAL field bit assignment follows 17.3.4 and Figure 111. The transmitted bits are shown in Table G.7, where bit 0 is transmitted first.

Table G.7—Bit assignment for SIGNAL field

##	Bit	Meaning	##	Bit	Meaning
0	1	RATE: R1	12	0	—
1	0	RATE: R2	13	0	—
2	1	RATE: R3	14	0	—
3	1	RATE: R4	15	0	—
4	0	Reserved	16	0	LENGTH (MSB)
5	0	LENGTH (LSB)	17	0	Parity
6	0	—	18	0	SIGNAL TAIL
7	1	—	19	0	SIGNAL TAIL
8	0	—	20	0	SIGNAL TAIL
9	0	—	21	0	SIGNAL TAIL
10	1	—	22	0	SIGNAL TAIL
11	1	—	23	0	SIGNAL TAIL

G.4.2 Coding the SIGNAL field bits.

The bits are encoded by the rate 1/2 convolutional encoder to yield the 48 bits given in Table G.8.

Table G.8—SIGNAL field bits after encoding

##	Bit	##	Bit	##	Bit	##	Bit	##	Bit	##	Bit
0	1	8	1	16	0	24	0	32	0	40	0
1	1	9	0	17	0	25	0	33	1	41	0
2	0	10	1	18	0	26	1	34	1	42	0
3	1	11	0	19	0	27	1	35	1	43	0
4	0	12	0	20	0	28	1	36	0	44	0
5	0	13	0	21	0	29	1	37	0	45	0
6	0	14	0	22	1	30	1	38	0	46	0
7	1	15	1	23	0	31	0	39	0	47	0

G.4.3 Interleaving the SIGNAL field bits.

The encoded bits are interleaved according to the interleaver of 17.3.5.6. A detailed breakdown of the interleaving operation is described in G.7. The interleaved SIGNAL field bits are shown in Table G.9.

Table G.9—SIGNAL field bits after interleaving

##	Bit	##	Bit	##	Bit	##	Bit	##	Bit	##	Bit
0	1	8	1	16	0	24	1	32	0	40	1
1	0	9	1	17	0	25	0	33	0	41	0
2	0	10	0	18	0	26	0	34	1	42	0
3	1	11	1	19	1	27	0	35	0	43	1
4	0	12	0	20	0	28	0	36	0	44	0
5	1	13	0	21	1	29	0	37	1	45	1
6	0	14	0	22	0	30	1	38	0	46	0
7	0	15	0	23	0	31	1	39	0	47	0

G.4.4 SIGNAL field frequency domain

The encoded and interleaved bits are BPSK modulated to yield the frequency domain representation given in Table G.10. Locations -21, -7, 7, and 21 are skipped and will be used for pilot insertion.

Table G.10—Frequency domain representation of SIGNAL field

##	Re	Im	##	Re	Im	##	Re	Im	##	Re	Im
-32	0.000	0.000	-16	1.000	0.000	0	0.000	0.000	16	-1.000	0.000
-31	0.000	0.000	-15	-1.000	0.000	1	1.000	0.000	17	-1.000	0.000
-30	0.000	0.000	-14	1.000	0.000	2	-1.000	0.000	18	1.000	0.000
-29	0.000	0.000	-13	-1.000	0.000	3	-1.000	0.000	19	-1.000	0.000
-28	0.000	0.000	-12	-1.000	0.000	4	-1.000	0.000	20	-1.000	0.000
-27	0.000	0.000	-11	-1.000	0.000	5	-1.000	0.000	21	X	X
-26	1.000	0.000	-10	-1.000	0.000	6	-1.000	0.000	22	1.000	0.000
-25	-1.000	0.000	-9	-1.000	0.000	7	X	X	23	-1.000	0.000
-24	-1.000	0.000	-8	-1.000	0.000	8	1.000	0.000	24	1.000	0.000
-23	1.000	0.000	-7	X	X	9	1.000	0.000	25	-1.000	0.000
-22	-1.000	0.000	-6	-1.000	0.000	10	-1.000	0.000	26	-1.000	0.000
-21	X	X	-5	1.000	0.000	11	-1.000	0.000	27	0.000	0.000
-20	1.000	0.000	-4	-1.000	0.000	12	1.000	0.000	28	0.000	0.000
-19	-1.000	0.000	-3	1.000	0.000	13	-1.000	0.000	29	0.000	0.000
-18	-1.000	0.000	-2	-1.000	0.000	14	-1.000	0.000	30	0.000	0.000
-17	1.000	0.000	-1	-1.000	0.000	15	1.000	0.000	31	0.000	0.000

Four pilot subcarriers are added by taking the values $\{1.0, 1.0, 1.0, -1.0\}$, multiplying them by the first element of sequence $p_{0...126}$, given in Equation (22), and inserting them into location $\{-21, -7, 7, 21\}$, respectively. The resulting frequency domain values are given in Table G.11.

Table G.11—Frequency domain representation of SIGNAL field with pilots inserted

##	Re	Im	##	Re	Im	##	Re	Im	##	Re	Im
-32	0.000	0.000	-16	1.000	0.000	0	0.000	0.000	16	-1.000	0.000
-31	0.000	0.000	-15	-1.000	0.000	1	1.000	0.000	17	-1.000	0.000
-30	0.000	0.000	-14	1.000	0.000	2	-1.000	0.000	18	1.000	0.000
-29	0.000	0.000	-13	-1.000	0.000	3	-1.000	0.000	19	-1.000	0.000
-28	0.000	0.000	-12	-1.000	0.000	4	-1.000	0.000	20	-1.000	0.000
-27	0.000	0.000	-11	-1.000	0.000	5	-1.000	0.000	21	-1.000	0.000
-26	1.000	0.000	-10	-1.000	0.000	6	-1.000	0.000	22	1.000	0.000
-25	-1.000	0.000	-9	-1.000	0.000	7	1.000	0.000	23	-1.000	0.000
-24	-1.000	0.000	-8	-1.000	0.000	8	1.000	0.000	24	1.000	0.000
-23	1.000	0.000	-7	1.000	0.000	9	1.000	0.000	25	-1.000	0.000
-22	-1.000	0.000	-6	-1.000	0.000	10	-1.000	0.000	26	-1.000	0.000
-21	1.000	0.000	-5	1.000	0.000	11	-1.000	0.000	27	0.000	0.000
-20	1.000	0.000	-4	-1.000	0.000	12	1.000	0.000	28	0.000	0.000
-19	-1.000	0.000	-3	1.000	0.000	13	-1.000	0.000	29	0.000	0.000
-18	-1.000	0.000	-2	-1.000	0.000	14	-1.000	0.000	30	0.000	0.000
-17	1.000	0.000	-1	-1.000	0.000	15	1.000	0.000	31	0.000	0.000

G.4.5 SIGNAL field time domain

The time domain representation is derived by performing IFFT on the contents of Table G.11, extending cyclically, and multiplying by the window function

$$W(k) = \begin{bmatrix} 0.5 & k = 0 \\ 1 & 1 \leq k \leq 8 \\ 0.5 & k = 80 \end{bmatrix}$$

The resulting 81 samples vector is shown in Table G.12. Note that the time-windowing feature illustrated here is not a part of the normative specifications.

The SIGNAL field samples are appended with one sample overlap to the preamble, given in Table G.6.

Table G.12—Time domain representation of SIGNAL field

##	Re	Im	##	Re	Im	##	Re	Im	##	Re	Im
0	0.031	0.000	1	0.033	-0.044	2	-0.002	-0.038	3	-0.081	0.084
4	0.007	-0.100	5	-0.001	-0.113	6	-0.021	-0.005	7	0.136	-0.105
8	0.098	-0.044	9	0.011	-0.002	10	-0.033	0.044	11	-0.060	0.124
12	0.010	0.097	13	0.000	-0.008	14	0.018	-0.083	15	-0.069	0.027
16	-0.219	0.000	17	-0.069	-0.027	18	0.018	0.083	19	0.000	0.008
20	0.010	-0.097	21	-0.060	-0.124	22	-0.033	-0.044	23	0.011	0.002
24	0.098	0.044	25	0.136	0.105	26	-0.021	0.005	27	-0.001	0.113
28	0.007	0.100	29	-0.081	-0.084	30	-0.002	0.038	31	0.033	0.044
32	0.062	0.000	33	0.057	0.052	34	0.016	0.174	35	0.035	0.116
36	-0.051	-0.202	37	0.011	0.036	38	0.089	0.209	39	-0.049	-0.008
40	-0.035	0.044	41	0.017	-0.059	42	0.053	-0.017	43	0.099	0.100
44	0.034	-0.148	45	-0.003	-0.094	46	-0.120	0.042	47	-0.136	-0.070
48	-0.031	0.000	49	-0.136	0.070	50	-0.120	-0.042	51	-0.003	0.094
52	0.034	0.148	53	0.099	-0.100	54	0.053	0.017	55	0.017	0.059
56	-0.035	-0.044	57	-0.049	0.008	58	0.089	-0.209	59	0.011	-0.036
60	-0.051	0.202	61	0.035	-0.116	62	0.016	-0.174	63	0.057	-0.052
64	0.062	0.000	65	0.033	-0.044	66	-0.002	-0.038	67	-0.081	0.084
68	0.007	-0.100	69	-0.001	-0.113	70	-0.021	-0.005	71	0.136	-0.105
72	0.098	-0.044	73	0.011	-0.002	74	-0.033	0.044	75	-0.060	0.124
76	0.010	0.097	77	0.000	-0.008	78	0.018	-0.083	79	-0.069	0.027
80	-0.109	0.000									

G.5 Generating the DATA bits

G.5.1 Delineating, SERVICE field prepending, and zero padding

The transmitted message shown in Table G.1 contains 100 octets or, equivalently, 800 bits. The bits are prepended by the 16 SERVICE field bits and are appended by 6 tail bits. The resulting 822 bits are appended by zero bits to yield an integer number of OFDM symbols. For the 36 Mbit/s mode, there are 144 data bits per OFDM symbol; the overall number of bits is $\text{ceil}(822/6) \times 144 = 864$. Hence, $864 - 822 = 42$ zero bits are appended.

The data bits are shown in Table G.13 and Table G.14. For clarity, only the first and last 144 bits are shown.

G.5.2 Scrambling

The 864 bits are scrambled by the scrambler of Figure 113. The initial state of the scrambler is the state 1011101. The generated scrambling sequence is given in Table G.15.

Table G.13—First 144 DATA bits

##	Bit	##	Bit	##	Bit	##	Bit	##	Bit	##	Bit
0	0	24	0	48	0	72	1	96	0	120	1
1	0	25	1	49	0	73	0	97	0	121	0
2	0	26	0	50	0	74	1	98	0	122	0
3	0	27	0	51	0	75	1	99	0	123	0
4	0	28	0	52	0	76	0	100	0	124	0
5	0	29	0	53	0	77	0	101	0	125	0
6	0	30	0	54	0	78	1	102	0	126	0
7	0	31	0	55	0	79	1	103	0	127	0
8	0	32	0	56	0	80	1	104	0	128	0
9	0	33	0	57	0	81	1	105	0	129	0
10	0	34	0	58	0	82	1	106	0	130	1
11	0	35	0	59	0	83	0	107	0	131	1
12	0	36	0	60	0	84	1	108	0	132	1
13	0	37	0	61	1	85	1	109	1	133	1
14	0	38	0	62	1	86	0	110	0	134	0
15	0	39	0	63	0	87	0	111	0	135	0
16	0	40	0	64	0	88	0	112	0	136	1
17	0	41	1	65	0	89	1	113	1	137	0
18	1	42	1	66	0	90	1	114	1	138	0
19	0	43	1	67	1	91	0	115	0	139	0
20	0	44	0	68	0	92	0	116	1	140	1
21	0	45	1	69	0	93	1	117	0	141	1
22	0	46	0	70	0	94	0	118	1	142	1
23	0	47	0	71	0	95	1	119	1	143	1

Table G.14—Last 144 DATA bits

##	Bit	##	Bit	##	Bit	##	Bit	##	Bit	##	Bit
720	0	744	0	768	1	792	1	816	0	840	0
721	0	745	0	769	0	793	1	817	0	841	0
722	0	746	0	770	1	794	1	818	0	842	0
723	0	747	0	771	0	795	0	819	0	843	0
724	0	748	0	772	0	796	1	820	0	844	0
725	1	749	1	773	1	797	0	821	0	845	0
726	0	750	0	774	1	798	1	822	0	846	0
727	0	751	0	775	0	799	0	823	0	847	0
728	1	752	0	776	1	800	1	824	0	848	0
729	1	753	0	777	0	801	0	825	0	849	0
730	1	754	1	778	0	802	0	826	0	850	0
731	0	755	0	779	0	803	1	827	0	851	0
732	1	756	1	780	0	804	1	828	0	852	0
733	1	757	1	781	1	805	0	829	0	853	0
734	1	758	1	782	1	806	0	830	0	854	0
735	0	759	0	783	0	807	1	831	0	855	0
736	1	760	0	784	0	808	1	832	0	856	0
737	0	761	1	785	1	809	0	833	0	857	0
738	1	762	0	786	0	810	1	834	0	858	0
739	0	763	0	787	1	811	1	835	0	859	0
740	0	764	1	788	1	812	0	836	0	860	0
741	1	765	1	789	0	813	1	837	0	861	0
742	1	766	1	790	1	814	1	838	0	862	0
743	0	767	0	791	1	815	1	839	0	863	0

Table G.15—Scrambling sequence for seed 1011101

0	0	16	1	32	0	48	1	64	0	80	0	96	0	112	1
1	1	17	0	33	1	49	1	65	1	81	0	97	0	113	0
2	1	18	1	34	1	50	1	66	1	82	1	98	1	114	0
3	0	19	0	35	0	51	1	67	1	83	1	99	0	115	1
4	1	20	1	36	1	52	0	68	0	84	1	100	0	116	1
5	1	21	0	37	0	53	1	69	0	85	0	101	1	117	0
6	0	22	0	38	0	54	0	70	0	86	1	102	0	118	0
7	0	23	1	39	0	55	0	71	1	87	1	103	0	119	0
8	0	24	1	40	0	56	1	72	1	88	1	104	0	120	1
9	0	25	1	41	1	57	0	73	1	89	1	105	0	121	0
10	0	26	0	42	0	58	1	74	1	90	0	106	0	122	1
11	1	27	0	43	1	59	0	75	1	91	0	107	0	123	1
12	1	28	1	44	0	60	0	76	1	92	1	108	1	124	1
13	0	29	1	45	1	61	0	77	1	93	0	109	0	125	0
14	0	30	1	46	0	62	1	78	0	94	1	110	0	126	1
15	1	31	1	47	1	63	1	79	0	95	1	111	0		

After scrambling, the 6 bits in location 816 (i.e., the 817th bit) to 821 (the 822nd bit) are zeroed. The first and last 144 scrambled bits are shown in Table G.16 and Table G.17, respectively.

Table G.16—First 144 bits after scrambling

##	Bit	##	Bit	##	Bit	##	Bit	##	Bit	##	Bit
0	0	24	1	48	1	72	0	96	0	120	0
1	1	25	0	49	1	73	1	97	0	121	0
2	1	26	0	50	1	74	0	98	1	122	1
3	0	27	0	51	1	75	0	99	0	123	1
4	1	28	1	52	0	76	1	100	0	124	1
5	1	29	1	53	1	77	1	101	1	125	0
6	0	30	1	54	0	78	1	102	0	126	1
7	0	31	1	55	0	79	1	103	0	127	0
8	0	32	0	56	1	80	1	104	0	128	1
9	0	33	1	57	0	81	1	105	0	129	1
10	0	34	1	58	1	82	0	106	0	130	1
11	1	35	0	59	0	83	1	107	0	131	0
12	1	36	1	60	0	84	0	108	1	132	0
13	0	37	0	61	1	85	1	109	1	133	1
14	0	38	0	62	0	86	1	110	0	134	0
15	1	39	0	63	1	87	1	111	0	135	0
16	1	40	0	64	0	88	1	112	1	136	1
17	0	41	0	65	1	89	0	113	1	137	0
18	0	42	1	66	1	90	1	114	1	138	1
19	0	43	0	67	0	91	0	115	1	139	1
20	1	44	0	68	0	92	1	116	0	140	1
21	0	45	0	69	0	93	1	117	0	141	1
22	0	46	0	70	0	94	1	118	1	142	0
23	1	47	1	71	1	95	0	119	1	143	0

G.6.1 Coding the DATA bits

The scrambled bits are coded with a rate Ω convolutional code. The first 144 scrambled bits of Table G.16 are mapped into the 192 bits of Table G.18.

Table G.17—Last 144 bits after scrambling

##	Bit	##	Bit	##	Bit	##	Bit	##	Bit	##	Bit
720	0	744	0	768	1	792	0	816	0	840	0
721	1	745	0	769	0	793	0	817	0	841	0
722	1	746	0	770	1	794	1	818	0	842	0
723	1	747	1	771	0	795	1	819	0	843	0
724	1	748	0	772	0	796	0	820	0	844	1
725	1	749	1	773	0	797	0	821	0	845	1
726	0	750	1	774	0	798	0	822	0	846	1
727	1	751	1	775	0	799	0	823	0	847	0
728	1	752	0	776	1	800	1	824	1	848	1
729	0	753	0	777	1	801	0	825	1	849	1
730	0	754	1	778	1	802	0	826	0	850	1
731	0	755	1	779	0	803	0	827	1	851	1
732	1	756	1	780	1	804	1	828	1	852	0
733	0	757	0	781	1	805	1	829	1	853	0
734	1	758	0	782	0	806	0	830	0	854	1
735	0	759	1	783	0	807	0	831	0	855	0
736	0	760	0	784	0	808	1	832	0	856	1
737	0	761	0	785	0	809	1	833	1	857	1
738	1	762	0	786	1	810	0	834	1	858	0
739	0	763	1	787	0	811	0	835	1	859	0
740	0	764	0	788	1	812	1	836	1	860	1
741	1	765	1	789	0	813	0	837	1	861	0
742	1	766	0	790	0	814	1	838	1	862	0
743	1	767	1	791	0	815	0	839	1	863	1

G.6.2 Interleaving the DATA bits

The interleaver is defined as a two-permutation process. We shall denote by k the index of the coded bit before the first permutation; i shall be the index after the first and before the second permutation; and j shall be the index after the second permutation, just prior to modulation mapping. The mapping from k to i is shown in Table G.19, and the mapping from i to j is shown in Table G.20.

As a specific example, consider the case of $k = 17$ (the 18th bit after encoding and puncturing). It is mapped by the first permutation to $i = 13$ and by the second permutation to $j = 12$ (the 13th bit before mapping).

The interleaved bits are shown in Table G.21.

Table G.18—Coded bits of first DATA symbol

##	Bit	##	Bit	##	Bit	##	Bit	##	Bit	##	Bit
0	0	32	1	64	0	96	1	128	1	160	1
1	0	33	0	65	1	97	0	129	1	161	1
2	1	34	0	66	0	98	0	130	0	162	1
3	0	35	1	67	0	99	0	131	0	163	0
4	1	36	1	68	1	100	1	132	0	164	0
5	0	37	1	69	0	101	1	133	0	165	0
6	1	38	0	70	1	102	1	134	0	166	0
7	1	39	1	71	0	103	1	135	0	167	0
8	0	40	1	72	1	104	1	136	0	168	1
9	0	41	0	73	1	105	1	137	1	169	1
10	0	42	1	74	1	106	0	138	0	170	0
11	0	43	1	75	1	107	0	139	0	171	1
12	1	44	0	76	1	108	0	140	0	172	0
13	0	45	1	77	0	109	0	141	0	173	0
14	0	46	0	78	1	110	0	142	1	174	1
15	0	47	1	79	1	111	0	143	1	175	1
16	1	48	1	80	1	112	1	144	1	176	1
17	0	49	0	81	1	113	1	145	1	177	1
18	1	50	0	82	1	114	0	146	1	178	1
19	0	51	1	83	0	115	0	147	0	179	0
20	0	52	1	84	1	116	1	148	0	180	1
21	0	53	0	85	0	117	0	149	0	181	0
22	0	54	1	86	0	118	0	150	0	182	1
23	1	55	0	87	0	119	0	151	0	183	1
24	1	56	0	88	1	120	0	152	0	184	1
25	1	57	0	89	1	121	1	153	0	185	0
26	1	58	0	90	0	122	1	154	0	186	1
27	1	59	1	91	0	123	1	155	1	187	1
28	0	60	1	92	0	124	0	156	1	188	0
29	0	61	1	93	0	125	0	157	0	189	0
30	0	62	0	94	1	126	1	158	0	190	1
31	0	63	1	95	0	127	1	159	1	191	0

Table G.19—First permutation

<i>k</i>	<i>i</i>	<i>k</i>	<i>i</i>	<i>k</i>	<i>i</i>	<i>k</i>	<i>i</i>	<i>k</i>	<i>i</i>	<i>k</i>	<i>i</i>	<i>k</i>	<i>i</i>	<i>k</i>	<i>i</i>
0	0	24	97	48	3	72	100	96	6	120	103	144	9	168	106
1	12	25	109	49	15	73	112	97	18	121	115	145	21	169	118
2	24	26	121	50	27	74	124	98	30	122	127	146	33	170	130
3	36	27	133	51	39	75	136	99	42	123	139	147	45	171	142
4	48	28	145	52	51	76	148	100	54	124	151	148	57	172	154
5	60	29	157	53	63	77	160	101	66	125	163	149	69	173	166
6	72	30	169	54	75	78	172	102	78	126	175	150	81	174	178
7	84	31	181	55	87	79	184	103	90	127	187	151	93	175	190
8	96	32	2	56	99	80	5	104	102	128	8	152	105	176	11
9	108	33	14	57	111	81	17	105	114	129	20	153	117	177	23
10	120	34	26	58	123	82	29	106	126	130	32	154	129	178	35
11	132	35	38	59	135	83	41	107	138	131	44	155	141	179	47
12	144	36	50	60	147	84	53	108	150	132	56	156	153	180	59
13	156	37	62	61	159	85	65	109	162	133	68	157	165	181	71
14	168	38	74	62	171	86	77	110	174	134	80	158	177	182	83
15	180	39	86	63	183	87	89	111	186	135	92	159	189	183	95
16	1	40	98	64	4	88	101	112	7	136	104	160	10	184	107
17	13	41	110	65	16	89	113	113	19	137	116	161	22	185	119
18	25	42	122	66	28	90	125	114	31	138	128	162	34	186	131
19	37	43	134	67	40	91	137	115	43	139	140	163	46	187	143
20	49	44	146	68	52	92	149	116	55	140	152	164	58	188	155
21	61	45	158	69	64	93	161	117	67	141	164	165	70	189	167
22	73	46	170	70	76	94	173	118	79	142	176	166	82	190	179
23	85	47	182	71	88	95	185	119	91	143	188	167	94	191	191

G.6.3 Mapping into symbols

The frequency domain symbols are generated by grouping 4 coded bits and mapping into complex 16-QAM symbols according to Table 84. For instance, the first 4 bits (0 1 1 1) are mapped to the complex value, $-0.316 + 0.316j$, inserted at subcarrier #26.

Four pilot subcarriers are added by taking the values $\{1.0, 1.0, 1.0, -1.0\}$, multiplying them by the second element of sequence p , given in Equation (22), and inserting them into location $\{-21, -7, 7, 21\}$, respectively.

The frequency domain is shown in Table G.22.

Table G.20—Second permutation

<i>i</i>	<i>j</i>	<i>i</i>	<i>j</i>	<i>i</i>	<i>j</i>	<i>i</i>	<i>j</i>	<i>i</i>	<i>j</i>	<i>i</i>	<i>j</i>	<i>i</i>	<i>j</i>	<i>i</i>	<i>j</i>
0	0	24	24	48	48	72	72	96	96	120	120	144	144	168	168
1	1	25	25	49	49	73	73	97	97	121	121	145	145	169	169
2	2	26	26	50	50	74	74	98	98	122	122	146	146	170	170
3	3	27	27	51	51	75	75	99	99	123	123	147	147	171	171
4	4	28	28	52	52	76	76	100	100	124	124	148	148	172	172
5	5	29	29	53	53	77	77	101	101	125	125	149	149	173	173
6	6	30	30	54	54	78	78	102	102	126	126	150	150	174	174
7	7	31	31	55	55	79	79	103	103	127	127	151	151	175	175
8	8	32	32	56	56	80	80	104	104	128	128	152	152	176	176
9	9	33	33	57	57	81	81	105	105	129	129	153	153	177	177
10	10	34	34	58	58	82	82	106	106	130	130	154	154	178	178
11	11	35	35	59	59	83	83	107	107	131	131	155	155	179	179
12	13	36	37	60	61	84	85	108	109	132	133	156	157	180	181
13	12	37	36	61	60	85	84	109	108	133	132	157	156	181	180
14	15	38	39	62	63	86	87	110	111	134	135	158	159	182	183
15	14	39	38	63	62	87	86	111	110	135	134	159	158	183	182
16	17	40	41	64	65	88	89	112	113	136	137	160	161	184	185
17	16	41	40	65	64	89	88	113	112	137	136	161	160	185	184
18	19	42	43	66	67	90	91	114	115	138	139	162	163	186	187
19	18	43	42	67	66	91	90	115	114	139	138	163	162	187	186
20	21	44	45	68	69	92	93	116	117	140	141	164	165	188	189
21	20	45	44	69	68	93	92	117	116	141	140	165	164	189	188
22	23	46	47	70	71	94	95	118	119	142	143	166	167	190	191
23	22	47	46	71	70	95	94	119	118	143	142	167	166	191	190

Table G.21—Interleaved bits of first DATA symbol

##	Bit	##	Bit	##	Bit	##	Bit	##	Bit	##	Bit
0	0	32	0	64	0	96	0	128	0	160	0
1	1	33	1	65	0	97	1	129	0	161	0
2	1	34	1	66	0	98	1	130	0	162	0
3	1	35	1	67	1	99	0	131	1	163	0
4	0	36	0	68	0	100	1	132	1	164	0
5	1	37	0	69	0	101	1	133	0	165	0
6	1	38	1	70	0	102	1	134	1	166	0
7	1	39	1	71	0	103	0	135	1	167	0
8	1	40	0	72	1	104	0	136	0	168	0
9	1	41	0	73	0	105	0	137	1	169	0
10	1	42	0	74	0	106	1	138	1	170	0
11	1	43	0	75	1	107	1	139	0	171	0
12	0	44	0	76	1	108	1	140	1	172	1
13	0	45	0	77	0	109	0	141	0	173	1
14	0	46	0	78	1	110	0	142	1	174	0
15	0	47	0	79	0	111	0	143	1	175	1
16	1	48	1	80	0	112	1	144	1	176	1
17	1	49	0	81	0	113	1	145	0	177	0
18	1	50	1	82	0	114	1	146	0	178	1
19	0	51	1	83	1	115	1	147	1	179	1
20	1	52	1	84	1	116	0	148	1	180	0
21	1	53	1	85	1	117	1	149	0	181	0
22	1	54	1	86	0	118	0	150	0	182	1
23	1	55	1	87	1	119	1	151	0	183	1
24	1	56	0	88	0	120	0	152	0	184	0
25	1	57	0	89	0	121	1	153	1	185	1
26	0	58	0	90	0	122	1	154	0	186	1
27	0	59	1	91	1	123	0	155	0	187	0
28	0	60	0	92	0	124	1	156	0	188	1
29	1	61	0	93	0	125	0	157	0	189	1
30	0	62	0	94	1	126	0	158	1	190	0
31	0	63	1	95	0	127	1	159	1	191	1

Table G.22—Frequency domain of first DATA symbol

##	Re	Im	##	Re	Im	##	Re	Im	##	Re	Im
-32	0.000	0.000	-16	-0.949	0.316	0	0.000	0.000	16	-0.316	-0.949
-31	0.000	0.000	-15	-0.949	-0.949	1	-0.316	0.949	17	-0.949	0.316
-30	0.000	0.000	-14	-0.949	-0.949	2	0.316	0.949	18	-0.949	-0.949
-29	0.000	0.000	-13	0.949	0.316	3	-0.949	0.316	19	-0.949	-0.949
-28	0.000	0.000	-12	0.316	0.316	4	0.949	-0.949	20	-0.949	-0.949
-27	0.000	0.000	-11	-0.949	-0.316	5	0.316	0.316	21	-1.000	0.000
-26	-0.316	0.316	-10	-0.949	-0.316	6	-0.316	-0.316	22	0.316	-0.316
-25	-0.316	0.316	-9	-0.949	-0.316	7	1.000	0.000	23	0.949	0.316
-24	0.316	0.316	-8	-0.949	-0.949	8	-0.316	0.949	24	-0.949	0.316
-23	-0.949	-0.949	-7	1.000	0.000	9	0.949	-0.316	25	-0.316	0.949
-22	0.316	0.949	-6	0.949	-0.316	10	-0.949	-0.316	26	0.316	-0.316
-21	1.000	0.000	-5	0.949	0.949	11	0.949	0.316	27	0.000	0.000
-20	0.316	0.316	-4	-0.949	-0.316	12	-0.316	0.949	28	0.000	0.000
-19	0.316	-0.949	-3	0.316	-0.316	13	0.949	0.316	29	0.000	0.000
-18	-0.316	-0.949	-2	-0.949	-0.316	14	0.949	-0.316	30	0.000	0.000
-17	-0.316	0.316	-1	-0.949	0.949	15	0.949	-0.949	31	0.000	0.000

The time domain samples are produced by performing IFFT, cyclically extending, and multiplying with the window function in the same manner as described in G.4.5. The time domain samples are appended with one sample overlap to the SIGNAL field symbol.

G.7 Generating the additional DATA symbols

The generation of the additional five data symbols follows the same procedure as described in Clause 5 of IEEE Std 802.11, 1999 Edition. Special attention should be paid to the scrambling of the pilot subcarriers. Table G.23 lists the polarity of the pilot subcarriers and the elements of the sequence $p_{0...126}$ for the DATA symbols. For completeness, the pilots in the SIGNAL are included as well. The symbols are appended one after the other with a one-sample overlap.

Table G.23—Polarity of the pilot subcarriers

i	OFDM symbol	Element of p_i	Pilot at #-21	Pilot at #-7	Pilot at #7	Pilot at #21
0	SIGNAL	1	1.0 +0 j	1.0 +0 j	1.0 +0 j	-1.0 +0 j
1	DATA 1	1	1.0 +0 j	1.0 +0 j	1.0 +0 j	-1.0 +0 j
2	DATA 2	1	1.0 +0 j	1.0 +0 j	1.0 +0 j	-1.0 +0 j
3	DATA 3	1	1.0 +0 j	1.0 +0 j	1.0 +0 j	-1.0 +0 j
4	DATA 4	-1	-1.0 +0 j	-1.0 +0 j	-1.0 +0 j	1.0 +0 j
5	DATA 5	-1	-1.0 +0 j	-1.0 +0 j	-1.0 +0 j	1.0 +0 j
6	DATA 6	-1	-1.0 +0 j	-1.0 +0 j	-1.0 +0 j	1.0 +0 j

G.8 The entire packet

The packet in its entirety is shown in Table G.24. The short sequences section, the long sequences section, the SIGNAL field, and the DATA symbols are separated by double lines.

Table G.24—The entire packet

##	Re	Im	##	Re	Im	##	Re	Im	##	Re	Im
0	0.023	0.023	1	-0.132	0.002	2	-0.013	-0.079	3	0.143	-0.013
4	0.092	0.000	5	0.143	-0.013	6	-0.013	-0.079	7	-0.132	0.002
8	0.046	0.046	9	0.002	-0.132	10	-0.079	-0.013	11	-0.013	0.143
12	0.000	0.092	13	-0.013	0.143	14	-0.079	-0.013	15	0.002	-0.132
16	0.046	0.046	17	-0.132	0.002	18	-0.013	-0.079	19	0.143	-0.013
20	0.092	0.000	21	0.143	-0.013	22	-0.013	-0.079	23	-0.132	0.002
24	0.046	0.046	25	0.002	-0.132	26	-0.079	-0.013	27	-0.013	0.143
28	0.000	0.092	29	-0.013	0.143	30	-0.079	-0.013	31	0.002	-0.132
32	0.046	0.046	33	-0.132	0.002	34	-0.013	-0.079	35	0.143	-0.013
36	0.092	0.000	37	0.143	-0.013	38	-0.013	-0.079	39	-0.132	0.002
40	0.046	0.046	41	0.002	-0.132	42	-0.079	-0.013	43	-0.013	0.143
44	0.000	0.092	45	-0.013	0.143	46	-0.079	-0.013	47	0.002	-0.132
48	0.046	0.046	49	-0.132	0.002	50	-0.013	-0.079	51	0.143	-0.013
52	0.092	0.000	53	0.143	-0.013	54	-0.013	-0.079	55	-0.132	0.002
56	0.046	0.046	57	0.002	-0.132	58	-0.079	-0.013	59	-0.013	0.143
60	0.000	0.092	61	-0.013	0.143	62	-0.079	-0.013	63	0.002	-0.132
64	0.046	0.046	65	-0.132	0.002	66	-0.013	-0.079	67	0.143	-0.013
68	0.092	0.000	69	0.143	-0.013	70	-0.013	-0.079	71	-0.132	0.002

Table G.24—The entire packet (continued)

##	Re	Im	##	Re	Im	##	Re	Im	##	Re	Im
72	0.046	0.046	73	0.002	-0.132	74	-0.079	-0.013	75	-0.013	0.143
76	0.000	0.092	77	-0.013	0.143	78	-0.079	-0.013	79	0.002	-0.132
80	0.046	0.046	81	-0.132	0.002	82	-0.013	-0.079	83	0.143	-0.013
84	0.092	0.000	85	0.143	-0.013	86	-0.013	-0.079	87	-0.132	0.002
88	0.046	0.046	89	0.002	-0.132	90	-0.079	-0.013	91	-0.013	0.143
92	0.000	0.092	93	-0.013	0.143	94	-0.079	-0.013	95	0.002	-0.132
96	0.046	0.046	97	-0.132	0.002	98	-0.013	-0.079	99	0.143	-0.013
100	0.092	0.000	101	0.143	-0.013	102	-0.013	-0.079	103	-0.132	0.002
104	0.046	0.046	105	0.002	-0.132	106	-0.079	-0.013	107	-0.013	0.143
108	0.000	0.092	109	-0.013	0.143	110	-0.079	-0.013	111	0.002	-0.132
112	0.046	0.046	113	-0.132	0.002	114	-0.013	-0.079	115	0.143	-0.013
116	0.092	0.000	117	0.143	-0.013	118	-0.013	-0.079	119	-0.132	0.002
120	0.046	0.046	121	0.002	-0.132	122	-0.079	-0.013	123	-0.013	0.143
124	0.000	0.092	125	-0.013	0.143	126	-0.079	-0.013	127	0.002	-0.132
128	0.046	0.046	129	-0.132	0.002	130	-0.013	-0.079	131	0.143	-0.013
132	0.092	0.000	133	0.143	-0.013	134	-0.013	-0.079	135	-0.132	0.002
136	0.046	0.046	137	0.002	-0.132	138	-0.079	-0.013	139	-0.013	0.143
140	0.000	0.092	141	-0.013	0.143	142	-0.079	-0.013	143	0.002	-0.132
144	0.046	0.046	145	-0.132	0.002	146	-0.013	-0.079	147	0.143	-0.013
148	0.092	0.000	149	0.143	-0.013	150	-0.013	-0.079	151	-0.132	0.002
152	0.046	0.046	153	0.002	-0.132	154	-0.079	-0.013	155	-0.013	0.143
156	0.000	0.092	157	-0.013	0.143	158	-0.079	-0.013	159	0.002	-0.132
160	-0.055	0.023	161	0.012	-0.098	162	0.092	-0.106	163	-0.092	-0.115
164	-0.003	-0.054	165	0.075	0.074	166	-0.127	0.021	167	-0.122	0.017
168	-0.035	0.151	169	-0.056	0.022	170	-0.060	-0.081	171	0.070	-0.014
172	0.082	-0.092	173	-0.131	-0.065	174	-0.057	-0.039	175	0.037	-0.098
176	0.062	0.062	177	0.119	0.004	178	-0.022	-0.161	179	0.059	0.015
180	0.024	0.059	181	-0.137	0.047	182	0.001	0.115	183	0.053	-0.004
184	0.098	0.026	185	-0.038	0.106	186	-0.115	0.055	187	0.060	0.088
188	0.021	-0.028	189	0.097	-0.083	190	0.040	0.111	191	-0.005	0.120
192	0.156	0.000	193	-0.005	-0.120	194	0.040	-0.111	195	0.097	0.083
196	0.021	0.028	197	0.060	-0.088	198	-0.115	-0.055	199	-0.038	-0.106
200	0.098	-0.026	201	0.053	0.004	202	0.001	-0.115	203	-0.137	-0.047

Table G.24—The entire packet (continued)

##	Re	Im	##	Re	Im	##	Re	Im	##	Re	Im
204	0.024	-0.059	205	0.059	-0.015	206	-0.022	0.161	207	0.119	-0.004
208	0.062	-0.062	209	0.037	0.098	210	-0.057	0.039	211	-0.131	0.065
212	0.082	0.092	213	0.070	0.014	214	-0.060	0.081	215	-0.056	-0.022
216	-0.035	-0.151	217	-0.122	-0.017	218	-0.127	-0.021	219	0.075	-0.074
220	-0.003	0.054	221	-0.092	0.115	222	0.092	0.106	223	0.012	0.098
224	-0.156	0.000	225	0.012	-0.098	226	0.092	-0.106	227	-0.092	-0.115
228	-0.003	-0.054	229	0.075	0.074	230	-0.127	0.021	231	-0.122	0.017
232	-0.035	0.151	233	-0.056	0.022	234	-0.060	-0.081	235	0.070	-0.014
236	0.082	-0.092	237	-0.131	-0.065	238	-0.057	-0.039	239	0.037	-0.098
240	0.062	0.062	241	0.119	0.004	242	-0.022	-0.161	243	0.059	0.015
244	0.024	0.059	245	-0.137	0.047	246	0.001	0.115	247	0.053	-0.004
248	0.098	0.026	249	-0.038	0.106	250	-0.115	0.055	251	0.060	0.088
252	0.021	-0.028	253	0.097	-0.083	254	0.040	0.111	255	-0.005	0.120
256	0.156	0.000	257	-0.005	-0.120	258	0.040	-0.111	259	0.097	0.083
260	0.021	0.028	261	0.060	-0.088	262	-0.115	-0.055	263	-0.038	-0.106
264	0.098	-0.026	265	0.053	0.004	266	0.001	-0.115	267	-0.137	-0.047
268	0.024	-0.059	269	0.059	-0.015	270	-0.022	0.161	271	0.119	-0.004
272	0.062	-0.062	273	0.037	0.098	274	-0.057	0.039	275	-0.131	0.065
276	0.082	0.092	277	0.070	0.014	278	-0.060	0.081	279	-0.056	-0.022
280	-0.035	-0.151	281	-0.122	-0.017	282	-0.127	-0.021	283	0.075	-0.074
284	-0.003	0.054	285	-0.092	0.115	286	0.092	0.106	287	0.012	0.098
288	-0.156	0.000	289	0.012	-0.098	290	0.092	-0.106	291	-0.092	-0.115
292	-0.003	-0.054	293	0.075	0.074	294	-0.127	0.021	295	-0.122	0.017
296	-0.035	0.151	297	-0.056	0.022	298	-0.060	-0.081	299	0.070	-0.014
300	0.082	-0.092	301	-0.131	-0.065	302	-0.057	-0.039	303	0.037	-0.098
304	0.062	0.062	305	0.119	0.004	306	-0.022	-0.161	307	0.059	0.015
308	0.024	0.059	309	-0.137	0.047	310	0.001	0.115	311	0.053	-0.004
312	0.098	0.026	313	-0.038	0.106	314	-0.115	0.055	315	0.060	0.088
316	0.021	-0.028	317	0.097	-0.083	318	0.040	0.111	319	-0.005	0.120
320	0.109	0.000	321	0.033	-0.044	322	-0.002	-0.038	323	-0.081	0.084
324	0.007	-0.100	325	-0.001	-0.113	326	-0.021	-0.005	327	0.136	-0.105
328	0.098	-0.044	329	0.011	-0.002	330	-0.033	0.044	331	-0.060	0.124
332	0.010	0.097	333	0.000	-0.008	334	0.018	-0.083	335	-0.069	0.027

Table G.24—The entire packet (continued)

##	Re	Im	##	Re	Im	##	Re	Im	##	Re	Im
336	-0.219	0.000	337	-0.069	-0.027	338	0.018	0.083	339	0.000	0.008
340	0.010	-0.097	341	-0.060	-0.124	342	-0.033	-0.044	343	0.011	0.002
344	0.098	0.044	345	0.136	0.105	346	-0.021	0.005	347	-0.001	0.113
348	0.007	0.100	349	-0.081	-0.084	350	-0.002	0.038	351	0.033	0.044
352	0.062	0.000	353	0.057	0.052	354	0.016	0.174	355	0.035	0.116
356	-0.051	-0.202	357	0.011	0.036	358	0.089	0.209	359	-0.049	-0.008
360	-0.035	0.044	361	0.017	-0.059	362	0.053	-0.017	363	0.099	0.100
364	0.034	-0.148	365	-0.003	-0.094	366	-0.120	0.042	367	-0.136	-0.070
368	-0.031	0.000	369	-0.136	0.070	370	-0.120	-0.042	371	-0.003	0.094
372	0.034	0.148	373	0.099	-0.100	374	0.053	0.017	375	0.017	0.059
376	-0.035	-0.044	377	-0.049	0.008	378	0.089	-0.209	379	0.011	-0.036
380	-0.051	0.202	381	0.035	-0.116	382	0.016	-0.174	383	0.057	-0.052
384	0.062	0.000	385	0.033	-0.044	386	-0.002	-0.038	387	-0.081	0.084
388	0.007	-0.100	389	-0.001	-0.113	390	-0.021	-0.005	391	0.136	-0.105
392	0.098	-0.044	393	0.011	-0.002	394	-0.033	0.044	395	-0.060	0.124
396	0.010	0.097	397	0.000	-0.008	398	0.018	-0.083	399	-0.069	0.027
400	-0.139	0.050	401	0.004	0.014	402	0.011	-0.100	403	-0.097	-0.020
404	0.062	0.081	405	0.124	0.139	406	0.104	-0.015	407	0.173	-0.140
408	-0.040	0.006	409	-0.133	0.009	410	-0.002	-0.043	411	-0.047	0.092
412	-0.109	0.082	413	-0.024	0.010	414	0.096	0.019	415	0.019	-0.023
416	-0.087	-0.049	417	0.002	0.058	418	-0.021	0.228	419	-0.103	0.023
420	-0.019	-0.175	421	0.018	0.132	422	-0.071	0.160	423	-0.153	-0.062
424	-0.107	0.028	425	0.055	0.140	426	0.070	0.103	427	-0.056	0.025
428	-0.043	0.002	429	0.016	-0.118	430	0.026	-0.071	431	0.033	0.177
432	0.020	-0.021	433	0.035	-0.088	434	-0.008	0.101	435	-0.035	-0.010
436	0.065	0.030	437	0.092	-0.034	438	0.032	-0.123	439	-0.018	0.092
440	0.000	-0.006	441	-0.006	-0.056	442	-0.019	0.040	443	0.053	-0.131
444	0.022	-0.133	445	0.104	-0.032	446	0.163	-0.045	447	-0.105	-0.030
448	-0.110	-0.069	449	-0.008	-0.092	450	-0.049	-0.043	451	0.085	-0.017
452	0.090	0.063	453	0.015	0.153	454	0.049	0.094	455	0.011	0.034
456	-0.012	0.012	457	-0.015	-0.017	458	-0.061	0.031	459	-0.070	-0.040
460	0.011	-0.109	461	0.037	-0.060	462	-0.003	-0.178	463	-0.007	-0.128
464	-0.059	0.100	465	0.004	0.014	466	0.011	-0.100	467	-0.097	-0.020

Table G.24—The entire packet (continued)

##	Re	Im	##	Re	Im	##	Re	Im	##	Re	Im
468	0.062	0.081	469	0.124	0.139	470	0.104	-0.015	471	0.173	-0.140
472	-0.040	0.006	473	-0.133	0.009	474	-0.002	-0.043	475	-0.047	0.092
476	-0.109	0.082	477	-0.024	0.010	478	0.096	0.019	479	0.019	-0.023
480	-0.058	0.016	481	-0.096	-0.045	482	-0.110	0.003	483	-0.070	0.216
484	-0.040	0.059	485	0.010	-0.056	486	0.034	0.065	487	0.117	0.033
488	0.078	-0.133	489	-0.043	-0.146	490	0.158	-0.071	491	0.254	-0.021
492	0.068	0.117	493	-0.044	0.114	494	-0.035	0.041	495	0.085	0.070
496	0.120	0.010	497	0.057	0.055	498	0.063	0.188	499	0.091	0.149
500	-0.017	-0.039	501	-0.078	-0.075	502	0.049	0.079	503	-0.014	-0.007
504	0.030	-0.027	505	0.080	0.054	506	-0.186	-0.067	507	-0.039	-0.027
508	0.043	-0.072	509	-0.092	-0.089	510	0.029	0.105	511	-0.144	0.003
512	-0.069	-0.041	513	0.132	0.057	514	-0.126	0.070	515	-0.031	0.109
516	0.161	-0.009	517	0.056	-0.046	518	-0.004	0.028	519	-0.049	0.000
520	-0.078	-0.005	521	0.015	-0.087	522	0.149	-0.104	523	-0.021	-0.051
524	-0.154	-0.106	525	0.024	0.030	526	0.046	0.123	527	-0.004	-0.098
528	-0.061	-0.128	529	-0.024	-0.038	530	0.066	-0.048	531	-0.067	0.027
532	0.054	-0.050	533	0.171	-0.049	534	-0.108	0.132	535	-0.161	-0.019
536	-0.070	-0.072	537	-0.177	0.049	538	-0.172	-0.050	539	0.051	-0.075
540	0.122	-0.057	541	0.009	-0.044	542	-0.012	-0.021	543	0.004	0.009
544	-0.030	0.081	545	-0.096	-0.045	546	-0.110	0.003	547	-0.070	0.216
548	-0.040	0.059	549	0.010	-0.056	550	0.034	0.065	551	0.117	0.033
552	0.078	-0.133	553	-0.043	-0.146	554	0.158	-0.071	555	0.254	-0.021
556	0.068	0.117	557	-0.044	0.114	558	-0.035	0.041	559	0.085	0.070
560	0.001	0.011	561	-0.099	-0.048	562	0.054	-0.196	563	0.124	0.035
564	0.092	0.045	565	-0.037	-0.066	566	-0.021	-0.004	567	0.042	-0.065
568	0.061	0.048	569	0.046	0.004	570	-0.063	-0.045	571	-0.102	0.152
572	-0.039	-0.019	573	-0.005	-0.106	574	0.083	0.031	575	0.226	0.028
576	0.140	-0.010	577	-0.132	-0.033	578	-0.116	0.088	579	0.023	0.052
580	-0.171	-0.080	581	-0.246	-0.025	582	-0.062	-0.038	583	-0.055	-0.062
584	-0.004	-0.060	585	0.034	0.000	586	-0.030	0.021	587	0.075	-0.122
588	0.043	-0.080	589	-0.022	0.041	590	0.026	0.013	591	-0.031	-0.018
592	0.059	0.008	593	0.109	0.078	594	0.002	0.101	595	-0.016	0.054
596	-0.059	0.070	597	0.017	0.114	598	0.104	-0.034	599	-0.024	-0.059

Table G.24—The entire packet (continued)

##	Re	Im	##	Re	Im	##	Re	Im	##	Re	Im
600	-0.081	0.051	601	-0.040	-0.069	602	-0.069	0.058	603	-0.067	0.117
604	0.007	-0.131	605	0.009	0.028	606	0.075	0.117	607	0.118	0.030
608	-0.041	0.148	609	0.005	0.098	610	0.026	0.002	611	-0.116	0.045
612	-0.020	0.084	613	0.101	0.006	614	0.205	-0.064	615	0.073	-0.063
616	-0.174	-0.118	617	-0.024	0.026	618	-0.041	0.129	619	-0.042	-0.053
620	0.148	-0.126	621	-0.030	-0.049	622	-0.015	-0.021	623	0.089	-0.069
624	-0.119	0.011	625	-0.099	-0.048	626	0.054	-0.196	627	0.124	0.035
628	0.092	0.045	629	-0.037	-0.066	630	-0.021	-0.004	631	0.042	-0.065
632	0.061	0.048	633	0.046	0.004	634	-0.063	-0.045	635	-0.102	0.152
636	-0.039	-0.019	637	-0.005	-0.106	638	0.083	0.031	639	0.226	0.028
640	0.085	-0.065	641	0.034	-0.142	642	0.004	-0.012	643	0.126	-0.043
644	0.055	0.068	645	-0.020	0.077	646	0.008	-0.056	647	-0.034	0.046
648	-0.040	-0.134	649	-0.056	-0.131	650	0.014	0.097	651	0.045	-0.009
652	-0.113	-0.170	653	-0.065	-0.230	654	0.065	-0.011	655	0.011	0.048
656	-0.091	-0.059	657	-0.110	0.024	658	0.074	-0.034	659	0.124	0.022
660	-0.037	0.071	661	0.015	0.002	662	0.028	0.099	663	-0.062	0.068
664	0.064	0.016	665	0.078	0.156	666	0.009	0.219	667	0.147	0.024
668	0.106	0.030	669	-0.080	0.143	670	-0.049	-0.100	671	-0.036	-0.082
672	-0.089	0.021	673	-0.070	-0.029	674	-0.086	0.048	675	-0.066	-0.015
676	-0.024	0.002	677	-0.030	-0.023	678	-0.032	0.020	679	-0.002	0.212
680	0.158	-0.024	681	0.141	-0.119	682	-0.146	0.058	683	-0.155	0.083
684	-0.002	-0.030	685	0.018	-0.129	686	0.012	-0.018	687	-0.008	-0.037
688	0.031	0.040	689	0.023	0.097	690	0.014	-0.039	691	0.050	0.019
692	-0.072	-0.141	693	-0.023	-0.051	694	0.024	0.099	695	-0.127	-0.116
696	0.094	0.102	697	0.183	0.098	698	-0.040	-0.020	699	0.065	0.077
700	0.088	-0.147	701	-0.039	-0.059	702	-0.057	0.124	703	-0.077	0.020
704	0.030	-0.120	705	0.034	-0.142	706	0.004	-0.012	707	0.126	-0.043
708	0.055	0.068	709	-0.020	0.077	710	0.008	-0.056	711	-0.034	0.046
712	-0.040	-0.134	713	-0.056	-0.131	714	0.014	0.097	715	0.045	-0.009
716	-0.113	-0.170	717	-0.065	-0.230	718	0.065	-0.011	719	0.011	0.048
720	-0.026	-0.021	721	-0.002	0.041	722	0.001	0.071	723	-0.037	-0.117
724	-0.106	-0.062	725	0.002	0.057	726	-0.008	-0.011	727	0.019	0.072
728	0.016	0.059	729	-0.065	-0.077	730	0.142	-0.062	731	0.087	0.025

Table G.24—The entire packet (continued)

##	Re	Im	##	Re	Im	##	Re	Im	##	Re	Im
732	-0.003	-0.103	733	0.107	-0.152	734	-0.054	0.036	735	-0.030	-0.003
736	0.058	-0.020	737	-0.028	0.007	738	-0.027	-0.099	739	0.049	-0.075
740	0.174	0.031	741	0.134	0.156	742	0.060	0.077	743	-0.010	-0.022
744	-0.084	0.040	745	-0.074	0.011	746	-0.163	0.054	747	-0.052	-0.008
748	0.076	-0.042	749	0.043	0.101	750	0.058	-0.018	751	0.003	-0.090
752	0.059	-0.018	753	0.023	-0.031	754	0.007	-0.017	755	0.066	-0.017
756	-0.135	-0.098	757	-0.056	-0.081	758	0.089	0.154	759	0.120	0.122
760	0.102	0.001	761	-0.141	0.102	762	0.006	-0.011	763	0.057	-0.039
764	-0.059	0.066	765	0.132	0.111	766	0.012	0.114	767	0.047	-0.106
768	0.160	-0.099	769	-0.076	0.084	770	-0.049	0.073	771	0.005	-0.086
772	-0.052	-0.108	773	-0.073	0.129	774	-0.129	-0.034	775	-0.153	-0.111
776	-0.193	0.098	777	-0.107	-0.068	778	0.004	-0.009	779	-0.039	0.024
780	-0.054	-0.079	781	0.024	0.084	782	0.052	-0.002	783	0.028	-0.044
784	0.040	0.018	785	-0.002	0.041	786	0.001	0.071	787	-0.037	-0.117
788	-0.106	-0.062	789	0.002	0.057	790	-0.008	-0.011	791	0.019	0.072
792	0.016	0.059	793	-0.065	-0.077	794	0.142	-0.062	795	0.087	0.025
796	-0.003	-0.103	797	0.107	-0.152	798	-0.054	0.036	799	-0.030	-0.003
800	0.039	-0.090	801	0.029	0.025	802	0.086	-0.029	803	0.087	-0.082
804	0.003	-0.036	805	-0.096	-0.089	806	-0.073	-0.046	807	0.105	-0.020
808	0.193	0.018	809	-0.053	-0.073	810	-0.118	-0.149	811	0.019	-0.019
812	-0.042	0.026	813	0.041	0.009	814	0.028	-0.076	815	-0.038	-0.068
816	-0.011	0.010	817	-0.134	-0.064	818	0.069	-0.067	819	0.057	0.006
820	-0.134	0.098	821	0.152	0.036	822	0.041	-0.085	823	-0.099	-0.049
824	0.089	-0.099	825	-0.046	0.018	826	-0.112	0.135	827	-0.064	0.018
828	-0.022	0.053	829	0.041	0.077	830	-0.021	0.145	831	0.007	0.179
832	0.059	0.041	833	0.023	0.064	834	0.062	0.022	835	0.110	-0.081
836	-0.016	-0.054	837	-0.014	-0.017	838	0.171	0.008	839	0.070	-0.027
840	-0.015	0.002	841	-0.012	0.053	842	-0.125	0.009	843	-0.040	0.012

Table G.24—The entire packet (continued)

##	Re	Im	##	Re	Im	##	Re	Im	##	Re	Im
844	0.036	0.114	845	0.007	0.090	846	-0.016	-0.082	847	-0.008	-0.013
848	0.091	0.030	849	0.072	-0.068	850	0.051	0.063	851	-0.004	0.049
852	-0.130	-0.048	853	-0.121	0.061	854	-0.095	0.078	855	0.011	0.005
856	0.049	0.001	857	-0.014	-0.011	858	0.009	-0.063	859	-0.031	0.040
860	-0.011	0.004	861	-0.033	-0.111	862	-0.115	0.137	863	-0.025	0.049
864	0.020	-0.160	865	0.029	0.025	866	0.086	-0.029	867	0.087	-0.082
868	0.003	-0.036	869	-0.096	-0.089	870	-0.073	-0.046	871	0.105	-0.020
872	0.193	0.018	873	-0.053	-0.073	874	-0.118	-0.149	875	0.019	-0.019
876	-0.042	0.026	877	0.041	0.009	878	0.028	-0.076	879	-0.038	-0.068
880	-0.006	0.005									